

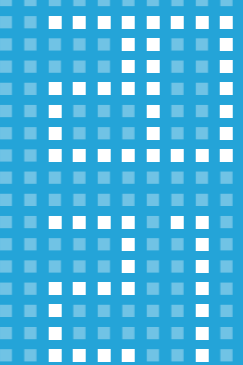

Better Security, Better World.



UNIVIEW

PRODUCT GUIDE

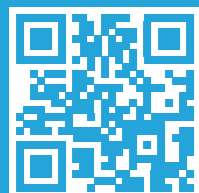

www.uniview.com

Sales: overseasbusiness@uniview.com
Technical Support: globalsupport@uniview.com

2021.03 OM - 210301-TB V1.0
All rights reserved, including final interpretation and content amendm

ABOUT US

Aiming to excellence

Uniview is a leading global manufacturer of professional video surveillance devices and solutions. As first to invent the network camera in China, Uniview has continued to bring cutting-edge technologies to the industry. Uniview provides complete product lines including network camera, network video recorder, storage, transmission, and display devices. With integrated solutions for various industries including retail, healthcare, finance, transportation, industrial park, and more, we are committed to bringing better security to the marketplace for building a better world.

Uniview has complete IP video surveillance product lines including network camera, NVR, VMS, professional storage, display and control devices, covering a diverse vertical markets including retail, building, industry, education, commercial, city surveillance etc.

Our aim is to become a global leader in video surveillance industry which endeavors to build a safer world by providing professional, reliable and cutting-edge products and services.

Vision

To become a global leader in video surveillance industry

Product line

Network Camera, NVR, VMS, Professional Storage, Display & Control



CONTENTS

01	Network Camera	
	Easy Series	03
	Prime Series	07
	Pro Series	23
	PTZ Camera	27
	Thermal Camera	35
	Consumer	37
39	NVR	
	Easy Series	41
	Prime Series	49
	Pro Series	49
	Kit	51
	Hybrid NVR	52
	AI XVR	53
54	VMS	
56	Professional Storage	
	Single Controller	57
	Dual Controller	58
	Expansion Unit	59
60	Display & Control	
	LCD Video Wall	61
	LED Displays	62
	Monitor	66
	Control	68
70	Accessories	
	IP Camera Bracket	71
	Switch	81
	Network Cable	82



Network Camera

Products from the Easy series are the most popular choices for entry-level applications such as residential and small retail stores. It consists of LB series IP cameras and the new Easystar series starlight cameras.

They all feature Ultra 265 compression technology developed exclusively by Uniview. Their most important business value is to provide excellent performance at an affordable price.

Besides, Easy series products are very easy to install and maintain, so they can be used anywhere in seconds. Easy series products are the most cost-effective option for residential and small business applications.



PixelSense Technology

PixelSense is Uniview's patented technology for switching Day & Night mode of IP camera. The traditional hardware switching method rely on an optical coupler which detects the illumination of the place where the camera is installed in. However, if the illumination of installation environment is different from real shooting scene's, the Day & Night switching might be triggered incorrectly.

UNV PixelSense technology is much more accurate. It detects the shooting scene's illumination (RGB) by the sensor of the camera, then drives IR-CUT to switch Day & Night mode. Besides, PixelSense technology is not rely on hardware optical coupler, that is the reason why it can reduce the failure rate.

Updated U-code Technology

U-code is a deep video compression technology which can reduce up to 90% bitrate in order to save bandwidth and storage space. U-code technology separates moving target and static background with different codec and adjusts GOP dynamically, meanwhile keeping good image quality. Recently, updated U-code supports frame rate controlling for different video content, we call it the dynamic frame rate. It is used to automatically maintain high frame rate monitoring for many moving objects scenario, but decrease the frame rate for few moving objects cases. No more details will be missed for complex surveillance images, and no more storages will be wasted for simple monitoring situation.

Easystar Series

If you hope to find the most cost-effective cameras that is also capable of presenting excellent color image performance, the new Easystar series is definitely the best choice. Those cameras hits the entry-level surveillance market with incredible starlight-level imaging performance and valuable price. There are 2MP bullet, dome, turret cameras and 4MP bullet, dome and turret cameras. The long night IR visible distance that up to 50m(bullet models only) offers best user experiences. Besides, the 4MP model support WDR which ensures excellent image quality in significant foreground and background illumination contrast. Easystar cameras is the optimal option for the small-to-medium business applications such as office park.

Easy to Use/Maintain

Easy series IP cameras support one-click firmware upgrade, upgrade via cloud, and plug & play for installers and end users to use easily. In troubleshooting, it's also easy to output diagnosis log by one-click. Easy series IP cameras can also detect the network connection regularly, once the network disconnection is detected, the IP camera will reset the network module inside of IP camera or reset the camera to recover.

Reliability at Design and Tests

From selective components to design product reliability during research and development, from process control during production to full-process traceability system, Uniview is dedicated to pursuit high quality. All sensor boards in UNV cameras are designed as 2mm thickness to avoid defocus by deformation while using in extremely harsh environment.



IPC2124LE-ADF28(40)KM-G

- 4MP@30fps (2688*1520)
- Ultra 265, up to 95% bandwidth reduction up to 50m IR distance
- 120dB true WDR
- Built-in Mic, Built-in SD card slot
- Support PoE, ±25% wide voltage tolerance
- Apply metal housing, IP67 water proof







IPC2128LR3-DPF28(40)M-F

- 8MP@20fps (3840*2160)
- Ultra 265, up to 95% bandwidth reduction
- Smart IR and anti-reflection glass design, up to 30m IR distance
- 120dB true WDR
- Support PoE, ±25% wide voltage tolerance
- Reset button, IP67 water proof

Easy Basic

Model	IPC2122LB-ADF28(40)KM-G	IPC322LB-DSF28(40)K-G	IPC3612LB-ADF28(40)K-G	IPC2322LB-ADZK-G	IPC3532LB-ADZK-G
Appearance					
Axis	3-Axis	3-Axis	3-Axis	3-Axis	3-Axis
Low illumination characteristics	Low-light	Low-light	Low-light	Low-light	Low-light
Adjustment angle	Pan: 0°~360° Tilt: 0°~90° Rotate: 0°~360°	Pan: 3°~360° Tilt: 0°~68° Rotate: 3°~360°	Pan: 0°~360° Tilt: 0°~80° Rotate: 0°~360°	Pan: 0°~360° Tilt: 0°~90° Rotate: 0°~360°	Pan: 0°~360° Tilt: 0°~70° Rotate: 0°~360°
Sensor	1/2.7"/2MP/CMOS	1/2.7"/2MP/CMOS	1/2.7"/2MP/CMOS	1/2.7"/2MP/CMOS	1/2.7"/2MP/CMOS
Wide Dynamic Range	120dB True WDR	120dB True WDR	120dB True WDR	120dB True WDR	120dB True WDR
Zoom	Fixed	Fixed	Fixed	Motorized	Motorized
Lens	Focus: 2.8mm,4.0mm Iris: F2.0 Angle of view (H):112.7°/91.2°	Focus: 2.8mm,4.0mm Iris: F2.0 Angle of view (H):112.7°/91.2°	Focus: 2.8mm,4.0mm Iris: F1.6 Angle of view (H):112.7°/91.2°	Focus: 2.8-12mm Iris: F1.6 Angle of view (H): 104.73° ~ 31.21°	Focus: 2.8-12mm Iris: F1.6 Angle of view (H): 104.73° ~ 31.21°
Iris	Fixed	Fixed	Fixed	Fixed	Fixed
Min. illumination	Color: 0.01Lux (F2.0, AGC ON) 0Lux with IR	Color: 0.01Lux (F2.0, AGC ON) 0Lux with IR	Color: 0.01Lux (F2.0, AGC ON) 0Lux with IR	Color: 0.005Lux (F1.6, AGC ON) 0Lux with IR	Color: 0.005Lux (F1.6, AGC ON) 0Lux with IR
IR/LED	Up to 30m (98ft)	Up to 30m (98ft)	Up to 30m (98ft)	Up to 50m (164ft)	Up to 40m (131ft)
Video Compression	Ultra 265, H.265, H.264, MJPEG	Ultra 265, H.265, H.264, MJPEG	Ultra 265, H.265, H.264, MJPEG	Ultra 265, H.265, H.264, MJPEG	Ultra 265, H.265, H.264, MJPEG
Smart Function	√	√	√	√	√
Frame Rate	1920×1080 30fps 1280×720 30fps	1920×1080 30fps 1280×720 30fps	1920×1080 30fps 1280×720 30fps	1920×1080 30fps 1280×720 30fps	1920×1080 30fps 1280×720 30fps
ROI (Region of Interest)	√	√	√	√	√
9:16 Corridor Mode	N/A	N/A	N/A	N/A	N/A
Video Streaming	Dual streams	Dual streams	Dual streams	Dual streams	Dual streams
Privacy Mask	√	√	√	√	√
OSD font	lattice	lattice	lattice	lattice	lattice
The number of OSD	Up to 4 OSDs	Up to 4 OSDs	Up to 4 OSDs	Up to 4 OSDs	Up to 4 OSDs
Audio I/O	Built-in Mic	N/A	Built-in Mic	Built-in Mic	Built-in Mic
Alarm I/O	N/A	N/A	N/A	N/A	N/A
BNC	N/A	N/A	N/A	N/A	N/A
Edge Storage	MicroSD, up to 128GB	Micro SD, up to 128GB	Micro SD, up to 128GB	MicroSD, up to 128GB	MicroSD, up to 128GB
Network Interface	10M/100M Base-TX Ethernet	10M/100M Base-TX Ethernet	10M/100M Base-TX Ethernet	10M/100M Base-TX Ethernet	10M/100M Base-TX Ethernet
Reset Button	N/A	N/A	N/A	√	√
Power	DC 12V ±25% PoE (IEEE 802.3af)	DC 12V ±25% PoE (IEEE 802.3af)	DC 12V ±25% PoE (IEEE 802.3af)	DC 12V ±25% PoE (IEEE 802.3af)	DC 12V ±25% PoE (IEEE 802.3af)
Working Environment	-30°C ~ 60°C (-22°F ~ 140°F)	-30°C ~ 60°C (-22°F ~ 140°F)	-30°C ~ 60°C (-22°F ~ 140°F)	-30°C ~ 60°C (-22°F ~ 140°F)	-30°C ~ 60°C (-22°F ~ 140°F)
Ingress Protection	IP67	IP67	IP67	IP67	IP67
Vandal Resistant	N/A	IK10	N/A	N/A	IK10
Weight	0.39kg (0.86lb)	0.36kg (0.79lb)	0.29kg (0.64lb)	0.54kg (1.2lb)	0.60kg (1.32lb)
Power Consumption	Max 7.0W	Max 5.0W	Max 7.0W	Max 8.0W	Max 8.2W
Dimensions (L × W × H)	165 × 63 × 62mm (6.5" × 2.5" × 2.5")	Φ 109 × 81mm (Φ 4.3" × 3.2")	Φ 118 × 96mm (Φ 4.6" × 3.8")	206 × 74 × 74mm (8.1" × 2.9" × 2.9")	Φ 128mm×100mm (Φ 5.0" × 3.9")

Easy Basic

Model	IPC3632LB-ADZK-G	IPC2123LB-AF28(40)KM-G	IPC323LB-SF28(40)K-G	IPC3613LB-AF28(40)K-G
Appearance				
Axis	3-Axis	3-Axis	3-Axis	3-Axis
Low illumination characteristics	Low-light	Low-light	Low-light	Low-light
Adjustment angle	Pan: 0°~360° Tilt: 0°~75° Rotate: 0°~360°	Pan: 0°~360° Tilt: 0°~90° Rotate: 0°~360°	Pan: 3°~360° Tilt: 0°~68° Rotate: 3°~360°	Pan: 3°~360° Tilt: 0°~80° Rotate: 3°~360°
Sensor	1/2.7"/2MP/CMOS	1/2.8"/3MP/CMOS	1/2.8"/3MP/CMOS	1/2.8"/3MP/CMOS
Wide Dynamic Range	120dB True WDR	/	/	/
Zoom	Motorized	Fixed	Fixed	Fixed
Lens	Focus: 2.8-12mm Iris: F2.0 Angle of view (H): 104.73° ~ 31.21°	Focus: 2.8mm,4.0mm Iris: F2.0 Angle of view (H):109.2°/89.0°	Focus: 2.8mm,4.0mm Iris: F2.0 Angle of view (H):109.2°/89.0°	Focus: 2.8mm,4.0mm Iris: F2.0 Angle of view (H):109.2°/89.0°
Iris	Fixed	Fixed	Fixed	Fixed
Min. illumination	Color: 0.005Lux (F1.6, AGC ON) 0Lux with IR	Color: 0.005Lux (F2.0, AGC ON) 0Lux with IR	Color: 0.005Lux (F2.0, AGC ON) 0Lux with IR	Color: 0.005Lux (F2.0, AGC ON) 0Lux with IR
IR/LED	Up to 40m (131ft)	Up to 30m (98ft)	Up to 30m (98ft)	Up to 30m (98ft)
Video Compression	Ultra 265, H.265, H.264, MJPEG	Ultra 265, H.265, H.264, MJPEG	Ultra 265, H.265, H.264, MJPEG	Ultra 265, H.265, H.264, MJPEG
Smart Function	√	√	√	√
Frame Rate	1920×1080 30fps 1280×720 30fps	2304×1296 25fps 1920×1080 30fps 1280×720 30fps	2304×1296 25fps 1920×1080 30fps 1280×720 30fps	2304×1296 25fps 1920×1080 30fps 1280×720 30fps
ROI (Region of Interest)	√	√	√	√
9:16 Corridor Mode	N/A	N/A	N/A	N/A
Video Streaming	Dual streams	Dual streams	Dual streams	Dual streams
Privacy Mask	√	√	√	√
OSD font	vector	lattice	lattice	lattice
The number of OSD	Up to 4 OSDs	Up to 4 OSDs	Up to 4 OSDs	Up to 4 OSDs
Audio I/O	Built-in Mic	Built-in Mic	N/A	Built-in Mic
Alarm I/O	N/A	N/A	N/A	N/A
BNC	N/A	N/A	N/A	N/A
Edge Storage	MicroSD, up to 128GB	MicroSD, up to 128GB	Micro SD, up to 128GB	Micro SD, up to 128GB
Network Interface	10M/100M Base-TX Ethernet	10M/100M Base-TX Ethernet	10M/100M Base-TX Ethernet	10M/100M Base-TX Ethernet
Reset Button	√	N/A	N/A	N/A
Power	DC 12V ±25% PoE (IEEE 802.3af)	DC 12V ±25% PoE (IEEE 802.3af)	DC 12V ±25% PoE (IEEE 802.3af)	DC 12V ±25% PoE (IEEE 802.3af)
Working Environment	-30°C ~ 60°C (-22°F ~ 140°F)	-30°C ~ 60°C (-22°F ~ 140°F)	-30°C ~ 60°C (-22°F ~ 140°F)	-30°C ~ 60°C (-22°F ~ 140°F)
Ingress Protection	IP67	IP67	IP67	IP67
Vandal Resistant	N/A	N/A	IK10	N/A
Weight	0.67kg (1.48lb)	0.39kg (0.86lb)	0.45kg (0.99lb)	0.33kg (0.73lb)
Power Consumption	Max 8.2W	Max 4.5W	Max 4.0W	Max 4.5W
Dimensions (L × W × H)	Φ 129 × 110mm (Φ 5.1" × 4.3")	167 × 63 × 62mm (6.6" × 2.5" × 2.5")	Φ 109 × 81mm (Φ 4.3" × 3.2")	Φ 118 × 96mm (Φ 4.6" × 3.8")

Easy Basic

Model	IPC2324LB-ADZK-G	IPC3534LB-ADZK-G	IPC3634LB-ADZK-G	IPC2128LR3-DPF28(40)M-F	IPC328LR3-DVSPF28(40)-F	IPC3618LR3-DPF28(40)-F
Appearance						
Axis	3-Axis	3-Axis	3-Axis	3-Axis	3-Axis	3-Axis
Low illumination characteristics	Low-light	Low-light	Low-light	Low-light	Low-light	Low-light
Adjustment angle	Pan: 0°~360° Tilt: 0°~90° Rotate: 0°~360°	Pan: 0°~360° Tilt: 0°~70° Rotate: 0°~360°	Pan: 0°~360° Tilt: 0°~70° Rotate: 0°~360°	Pan: 0°~360° Tilt: 0°~90° Rotate: 0°~360°	Pan: 0°~360° Tilt: 0°~80° Rotate: 0°~360°	Pan: 0°~360° Tilt: 0°~80° Rotate: 0°~360°
Sensor	1/3"/4MP/CMOS	1/3"/4MP/CMOS	1/3"/4MP/CMOS	1/3"/8MP/CMOS	1/3"/8MP/CMOS	1/3"/8MP/CMOS
Wide Dynamic Range	120dB True WDR	120dB True WDR	120dB True WDR	120dB True WDR	120dB True WDR	120dB True WDR
Zoom	Motorized	Motorized	Motorized	Fixed	Fixed	Fixed
Lens	Focus: 2.8-12mm Iris: F1.6 Angle of view (H): 109.06°~ 57.96°	Focus: 2.8-12mm Iris: F1.6 Angle of view (H): 109.06°~ 57.96°	Focus: 2.8-12mm Iris: F1.6 Angle of view (H): 109.06°~ 57.96°	Focus: 2.8mm, 4.0mm Iris: F2.0 Angle of view (H): 112.7°/86.5°	Focus: 2.8mm, 4.0mm Iris: F2.0 Angle of view (H): 112.7°/86.5°	Focus: 2.8mm, 4.0mm Iris: F2.0 Angle of view (H): 112.7°/86.5°
Iris	Fixed	Fixed	Fixed	Fixed	Fixed	Fixed
Min. illumination	Color: 0.003Lux (F1.6, AGC ON) 0Lux with IR	Color: 0.003Lux (F1.6, AGC ON) 0Lux with IR	Color: 0.003Lux (F1.6, AGC ON) 0Lux with IR	Color: 0.05Lux (F2.0, AGC ON) 0Lux with IR	Color: 0.05Lux (F2.0, AGC ON) 0Lux with IR	Color: 0.05Lux (F2.0, AGC ON) 0Lux with IR
IR/LED	Up to 50m (164ft)	Up to 40m (131ft)	Up to 40m (131ft)	Up to 30m (98ft)	Up to 30m (98ft)	Up to 30m (98ft)
Video Compression	Ultra 265, H.265, H.264, MJPEG	Ultra 265, H.265, H.264, MJPEG	Ultra 265, H.265, H.264, MJPEG	Ultra 265, H.265, H.264, MJPEG	Ultra 265, H.265, H.264, MJPEG	Ultra 265, H.265, H.264, MJPEG
Smart Function	√	√	√	√	√	√
Frame Rate	2688x1520 25fps 2560x1440 25fps 2304x1296 25fps 1920x1080 30fps	2688x1520 25fps 2560x1440 25fps 2304x1296 25fps 1920x1080 30fps	2688x1520 25fps 2560x1440 25fps 2304x1296 25fps 1920x1080 30fps	3840x2160 20fps 2592x1944 30fps 2944x1656 30fps 2560x1440 30fps 1920x1080 30fps	3840x2160 20fps 2592x1944 30fps 2944x1656 30fps 2560x1440 30fps 1920x1080 30fps	3840x2160 20fps 2592x1944 30fps 2944x1656 30fps 2560x1440 30fps 1920x1080 30fps
ROI (Region of Interest)	√	√	√	√	√	√
9:16 Corridor Mode	N/A	N/A	N/A	N/A	N/A	N/A
Video Streaming	Dual streams	Dual streams	Dual streams	Triple streams	Triple streams	Triple streams
Privacy Mask	√	√	√	√	√	√
OSD font	vector	vector	vector	lattice	lattice	lattice
The number of OSD	Up to 4 OSDs	Up to 4 OSDs	Up to 4 OSDs	Up to 4 OSDs	Up to 4 OSDs	Up to 4 OSDs
Audio I/O	Built-in Mic	Built-in Mic	Built-in Mic	N/A	N/A	N/A
Alarm I/O	N/A	N/A	N/A	N/A	N/A	N/A
BNC	N/A	N/A	N/A	N/A	N/A	N/A
Edge Storage	MicroSD, up to 256GB	MicroSD, up to 256GB	MicroSD, up to 256GB	N/A	N/A	N/A
Network Interface	10M/100M Base-TX Ethernet	10M/100M Base-TX Ethernet	10M/100M Base-TX Ethernet	10M/100M Base-TX Ethernet	10M/100M Base-TX Ethernet	10M/100M Base-TX Ethernet
Reset Button	√	√	√	√	N/A	N/A
Power	DC 12V ±25% PoE (IEEE 802.3af)	DC 12V ±25% PoE (IEEE 802.3af)	DC 12V ±25% PoE (IEEE 802.3af)	DC 12V ±25% PoE (IEEE 802.3af)	DC 12V ±25% PoE (IEEE 802.3af)	DC 12V ±25% PoE (IEEE 802.3af)
Working Environment	-30°C ~ 60°C (-22°F ~ 140°F)	-30°C ~ 60°C (-22°F ~ 140°F)	-30°C ~ 60°C (-22°F ~ 140°F)	-30°C ~ 60°C (-22°F ~ 140°F)	-35°C ~ +60°C (-31°F ~ 140°F)	-30°C ~ 60°C (-22°F ~ 140°F)
Ingress Protection	IP67	IP67	IP67	IP67	IP67	IP67
Vandal Resistant	N/A	IK10	N/A	N/A	IK10	N/A
Weight	0.54kg (1.21lb)	0.60kg (1.32lb)	0.67kg (1.48lb)	0.45kg (0.99lb)	0.45kg (0.99lb)	0.33kg (0.73lb)
Power Consumption	Max 8.0W	Max 8.2W	Max 8.2W	Max 5.5W	Max 5.5W	Max 5W
Dimensions (L x W x H)	206 x 74 x 74mm (8.1" x 2.9" x 2.9")	φ128mmx100mm (φ5.0" x 3.9")	φ129 x 110mm (φ5.1" x 4.3")	167.3x62.9x62.7 mm(6.6"x2.5"x2.5")	φ108.7 x 81.1mm (φ4.3" x 3.2")	φ118x96mm (φ4.6"x3.8")

EasyStar

Model	IPC2122LR5-UPF28(40)M-F	IPC322LR3-UVSPF28(40)-F	IPC3612LR3-UPF28(40)-F	IPC2124LE-ADF28(40)KM-G	IPC324LE-DSF28(40)K-G	IPC3614LE-ADF28(40)K
Appearance						
Axis	3-Axis	2-Axis	3-Axis	3-Axis	3-Axis	3-Axis
Low illumination characteristics	EasyStar	EasyStar	EasyStar	EasyStar	EasyStar	EasyStar
Adjustment angle	Pan: 0°~360° Tilt: 0°~90° Rotate: 0°~360°	Pan: 0°~360° Tilt: 0°~75°	Pan: 0°~360° Tilt: 0°~80° Rotate: 0°~360°	Pan: 0°~360° Tilt: 0°~90° Rotate: 0°~360°	Pan: 0°~360° Tilt: 0°~68° Rotate: 0°~360°	Pan: 0°~360° Tilt: 0°~80° Rotate: 0°~360°
Sensor	1/2.7"/2MP/CMOS	1/2.7"/2MP/CMOS	1/2.7"/2MP/CMOS	1/3"/4MP/CMOS	1/3"/4MP/CMOS	1/3"/4MP/CMOS
Wide Dynamic Range	Digital WDR	Digital WDR	Digital WDR	120dB True WDR	120dB True WDR	120dB True WDR
Zoom	Fixed	Fixed	Fixed	Fixed	Fixed	Fixed
Lens	Focus: 2.8mm, 4mm Iris: F1.6 Angle of view(H): 112.7°/86.5°	Focus: 2.8mm, 4mm Iris: F1.6 Angle of view(H): 112.7°/86.5°	Focus: 2.8mm, 4mm Iris: F1.6 Angle of view(H): 112.7°/86.5°	Focus: 2.8mm, 4mm Iris: F1.6 Angle of view(H): 101.1°/83.7°	Focus: 2.8mm, 4mm Iris: F1.6 Angle of view(H): 101.1°/83.7°	Focus: 2.8mm, 4mm Iris: F1.6 Angle of view(H): 101.1°/83.7°
Iris	Fixed	Fixed	Fixed	Fixed	Fixed	Fixed
Min. illumination	Color: 0.005Lux (F1.6, AGC ON) 0Lux with IR	Color: 0.005Lux (F1.6, AGC ON) 0Lux with IR	Color: 0.005Lux (F1.6, AGC ON) 0Lux with IR	Color: 0.003Lux (F1.6, AGC ON) 0Lux with IR	Color: 0.003Lux (F1.6, AGC ON) 0Lux with IR	Color: 0.003Lux (F1.6, AGC ON) 0Lux with IR
IR	Up to 50m (164ft)	Up to 30m (98ft)	Up to 30m (98ft)	Up to 30m (98ft)	Up to 30m (98ft)	Up to 30m (98ft)
Video Compression	Ultra265, H.265, H.264	Ultra265, H.265, H.264	Ultra265, H.265, H.264	Ultra265, H.265, H.264, MJPEG	Ultra265, H.265, H.264, MJPEG	Ultra265, H.265, H.264, MJPEG
Smart Function	√	√	√	√	√	√
Frame Rate	1920x1080 30fps	1920x1080 30fps	1920x1080 30fps	2688x1520 25fps 2560x1440 25fps 2304x1296 25fps 1920x1080 30fps	2688x1520 25fps 2560x1440 25fps 2304x1296 25fps 1920x1080 30fps	2688x1520 25fps 2560x1440 25fps 2304x1296 25fps 1920x1080 30fps
ROI (Region of Interest)	√	√	√	√	√	√
9:16 Corridor Mode	N/A	N/A	N/A	N/A	N/A	N/A
Video Streaming	Dual streams	Dual streams	Dual streams	Dual streams	Dual streams	Dual streams
Privacy Mask	√	√	√	√	√	√
OSD font	lattice	lattice	lattice	vector	vector	vector
The number of OSD	Up to 4 OSDs	Up to 4 OSDs	Up to 4 OSDs	Up to 4 OSDs	Up to 4 OSDs	Up to 4 OSDs
Audio I/O	N/A	N/A	N/A	Built-in Mic	N/A	Built-in Mic
Alarm I/O	N/A	N/A	N/A	N/A	N/A	N/A
BNC	N/A	N/A	N/A	N/A	N/A	N/A
Edge Storage	N/A	N/A	N/A	MicroSD, up to 256GB	MicroSD, up to 256GB	MicroSD, up to 256GB
Network Interface	10M/100M Base-TX Ethernet	10M/100M Base-TX Ethernet	10M/100M Base-TX Ethernet	10M/100M Base-TX Ethernet	10M/100M Base-TX Ethernet	10M/100M Base-TX Ethernet
Reset Button	N/A	N/A	N/A	N/A	N/A	N/A
Power	DC 12V ±25% PoE (IEEE 802.3af)	DC 12V ±25% PoE (IEEE 802.3af)	DC 12V ±25% PoE (IEEE 802.3af)	DC 12V ±25% PoE (IEEE 802.3af)	DC 12V ±25% PoE (IEEE 802.3af)	DC 12V ±25% PoE (IEEE 802.3af)
Working Environment	-30°C ~ 60°C (-22°F ~ 140°F)	-30°C ~ 60°C (-22°F ~ 140°F)	-30°C ~ 60°C (-22°F ~ 140°F)	-30°C ~ 60°C (-22°F ~ 140°F)	-30°C ~ 60°C (-22°F ~ 140°F)	-30°C ~ 60°C (-22°F ~ 140°F)
Ingress Protection	IP67	IP67	IP67	IP67	IP67	IP67
Vandal Resistant	N/A	IK10	N/A	N/A	IK10	N/A
Weight	0.5kg (1.1lb)	0.37kg (0.81lb)	0.3kg (0.44lb)	0.5kg (1.1lb)	0.49kg (1.08lb)	0.35kg (0.77lb)
Power Consumption	Max 6W	Max 4.5W	Max 4.5W	Max 6W	Max 3.5W	Max 3.0W
Dimensions (L x W x H)	191.3x72.6x70.9mm (7.5"x2.9"x2.8")	φ109 x 81mm (φ4.3" x 3.2")	φ118 x 96mm (φ4.6" x 3.8")	191.3x72.6x70.9mm (7.5"x2.9"x2.8")	φ109 x 81mm (φ4.3" x 3.2")	φ118 x 96mm (φ4.6" x 3.8")

PRIME

Network Camera

Incredibly, you can always find the ideal product in the UNV Prime range, which has even more advanced features to achieve excellent performance. It consists of four subseries, each of which is designed specifically for a particular market. Prime-IV cameras have algorithms that reduce false positives. Prime-III is professional cameras for color imaging in ultra-low light conditions powered by LightHunter and ColorHunter.

The Prime-II series is a standard camera with a variety of smart features. Compared to the Easy series, the Prime-I series has enhanced hardware such as WDR, audio, alarm, SD cards. Available in a variety of mainstream resolutions, such as 2/4/5/ 8MP, different levels of image quality can be displayed. SB series also features intelligent intrusion prevention to reduce false positives. Prime products are commonly used in commercial buildings, parks and small project applications to effectively ensure safety.



IPC2325SB-DZK-10

- 5MP@25fps (2880*1620)
- Ultra 265, up to 95% bandwidth reduction
- Smart IR and anti-reflection glass design, up to 50m IR distance
- 120dB true WDR
- Smart intrusion prevention
- Audio I/O, Alarm I/O, Built-in SD card slot
- Support PoE, $\pm 25\%$ wide voltage tolerance
- Apply metal housing, IP67 water proof & IK10

LightHunter

The LightHunter Technology is an innovative technology that delivers vivid color, appropriate brightness, and extremely clear images in ultra-low light condition. It significantly improves the image brightness with F1.2 Large Iris design & BSI sensor. With the specially designed large size sensors, the IP cameras have higher photosensitivity, and feature high SNR. Besides, UNV's unique patented technology U-ISP features the new generation of noise reduction algorithm helps to produce no smearing image at Low-Blur mode. It effectively reduces blurring during objects' moving, which ensures that the image is restored to the true scene. Combining hardware and software advantages, LightHunter Technology guarantees the image full of color under ultra-low light condition.

Smart Intrusion Prevention

In security monitoring, most users only need to pay attention to real events: alarms triggered by people and vehicles. UNV Intelligent Intrusion Prevention (SIP) filters error alerts and allows human and vehicle classification to focus only on interest targets.

Environment Adaptability

Environment adaptability includes network adaptability for packet loss, image adaptability



IPC354SR3-ADNPF28-F

- 4MP@30fps (2688*1520)
- Ultra 265, up to 95% bandwidth reduction
- Smart IR and anti-reflection glass design, up to 30m IR distance
- 120dB true WDR
- Audio 1/1/, Alarm 1/1
- Cable-free design
- Support up to 128GB Micro SD card storage
- Support PoE, $\pm 25\%$ wide voltage tolerance

for different surveillance scenes (Starlight mode for low light, auto WDR/HLC/Defog, and Smart IR) and environment adaptability (auto heating at low temperature and snow removal).

More Reliable More Efficient

Prime series IP cameras support wide working temperature range and input voltage. In the IK10 dome cameras, the professional FFC cable can deliver a better EMC test result. Image distortion rectifying algorithm is used for all wide angle lens at wide side.

Deep Learning Intelligence

Prime-IV series cameras utilize intelligent chip and algorithm that can filter out useless target like leaves, animals, rain, birds to get precise target classification of vehicle and human. Besides, Prime-IV cameras support accurate smart intrusion prevention that effectively reduce false alarm. What's more, face detection, people counting are also featured.

Prime I

Model	IPC2122SB-ADF28(40)KM-I0	IPC322SB-DF28(40)K-I0	IPC3612SB-ADF28(40)KM-I0	IPC312SB-ADF28K-I0	IPC2322SB-DZK-I0
Appearance					
Axis	3-Axis	3-Axis	3-Axis	3-Axis	3-Axis
Low illumination characteristics	LightHunter	LightHunter	LightHunter	LightHunter	LightHunter
Adjustment angle	Pan: 0°~360° Tilt: 0°~90° Rotate: 0°~360°	Pan: 3°~360° Tilt: 0°~68° Rotate: 3°~360°	Pan: 0°~360° Tilt: 0°~75° Rotate: 0°~360°	Pan: 0°~90° Tilt: 0°~68° Rotate: 0°~360°	Pan: 0°~360° Tilt: 0°~90° Rotate: 0°~360°
Sensor	1/2.8"/2MP/CMOS	1/2.8"/2MP/CMOS	1/2.8"/2MP/CMOS	1/2.8"/2MP/CMOS	1/2.8"/2MP/CMOS
Wide Dynamic Range	120dB True WDR	120dB True WDR	120dB True WDR	120dB True WDR	120dB True WDR
Zoom	Fixed	Fixed	Fixed	Fixed	Motorized
Lens	Focus: 2.8mm, 4mm Iris: F1.6 Angle of view (H): 106.7°/87.5°	Focus: 2.8mm, 4mm Iris: F1.6 Angle of view (H): 106.7°/87.5°	Focus: 2.8mm, 4mm Iris: F1.6 Angle of view (H): 106.7°/87.5°	Focus: 2.8mm, 4mm Iris: F1.6 Angle of view (H): 106.7°	Focus: 2.7~13.5mm Iris: F1.2 Angle of view (H): 121.36°~ 33.51°
Iris	Fixed	Fixed	Fixed	Fixed	Fixed
Min. illumination	Color: 0.001Lux (F1.6, AGC ON) 0Lux with IR	Color: 0.001Lux (F1.6, AGC ON) 0Lux with IR	Color: 0.001Lux (F1.6, AGC ON) 0Lux with IR	Color: 0.001Lux (F1.6, AGC ON) 0Lux with IR	Color: 0.0005Lux (F1.2, AGC ON) 0Lux with IR
IR	Up to 40m (131ft)	Up to 30m (98ft)	Up to 30m (98ft)	Up to 30m (98ft)	Up to 50m (164ft)
Video Compression	Ultra 265, H.265, H.264, MJPEG	Ultra 265, H.265, H.264, MJPEG	Ultra 265, H.265, H.264, MJPEG	Ultra 265, H.265, H.264, MJPEG	Ultra 265, H.265, H.264, MJPEG
Smart Function	√	√	√	√	√
Frame Rate	1920*1080 30fps 1280*720 30fps	1920*1080 30fps 1280*720 30fps	1920*1080 30fps 1280*720 30fps	1920*1080 30fps 1280*720 30fps	1920*1080 30fps 1280*720 30fps
ROI (Region of Interest)	√	√	√	√	√
9:16 Corridor Mode	√	√	√	√	√
Video Streaming	Triple streams	Triple streams	Triple streams	Triple streams	Triple streams
Privacy Mask	√	√	√	√	√
OSD font	vector	vector	vector	vector	vector
The number of OSD	Up to 8 OSDs	Up to 8 OSDs	Up to 8 OSDs	Up to 8 OSDs	Up to 8 OSDs
Audio I/O	Built-in Mic	1 / 1	Built-in Mic	Built-in Mic	1 / 1
Alarm I/O	N/A	1 / 1	N/A	N/A	1 / 1
BNC	N/A	N/A	N/A	N/A	N/A
Edge Storage	MicroSD, up to 256GB	MicroSD, up to 256GB	MicroSD, up to 256GB	MicroSD, up to 256GB	MicroSD, up to 256GB
Network Interface	10M/100M Base-TX Ethernet	10M/100M Base-TX Ethernet	10M/100M Base-TX Ethernet	10M/100M Base-TX Ethernet	10M/100M Base-TX Ethernet
Reset Button	√	√	N/A	N/A	N/A
Power	DC 12V ±25% PoE (IEEE 802.3af)	DC 12V ±25% PoE (IEEE 802.3af)	DC 12V ±25% PoE (IEEE 802.3af)	DC 12V ±25% PoE (IEEE 802.3af)	DC 12V ±25% PoE (IEEE 802.3af)
Working Environment	-30°C ~ 60°C (-22°F ~ 140°F)	-30°C ~ 60°C (-22°F ~ 140°F)	-30°C ~ 60°C (-22°F ~ 140°F)	-30°C ~ 60°C (-22°F ~ 140°F)	-30°C ~ 60°C (-22°F ~ 140°F)
Ingress Protection	IP67	IP67	IP67	IP67	IP67
Vandal Resistant	N/A	IK10	N/A	IK10	IK10
Weight	0.42kg(0.93lb)	0.42kg(0.93lb)	0.42kg(0.93lb)	0.37kg(0.82lb)	0.92kg(2.03lb)
Power Consumption	Max 6.0W	Max 5.0W	Max 5.0W	Max 6.0W	Max 9.5W
Dimensions(L × W × H)	155.9 × 63.1 × 62.7mm(6.1" × 2.5" × 2.5")	Φ 108.7 × 81.1mm (Φ 4.3" × 3.2")	Φ 110.5 × 94.1mm (Φ 4.4" × 3.7")	Φ 110 × 65mm (Φ 4.3" × 2.4")	245.4 × 85.4 × 86.4mm (9.7" × 3.4" × 3.4")

Prime I

Model	IPC3232SB-ADZK-I0	IPC3632SB-ADZK-I0	IPC2124SR3-ADPF28(40)M-F	IPC2124SB-ADF28(40)KM-I0	IPC324SR3-DVPF28(40)-F
Appearance					
Axis	3-Axis	3-Axis	3-Axis	3-Axis	3-Axis
Low illumination characteristics	LightHunter	LightHunter	Low-light	LightHunter	Low-light
Adjustment angle	Pan: 0°~355° Tilt: 0°~80° Rotate: 0°~355°	Pan: 0°~360° Tilt: 0°~75° Rotate: 0°~360°	Pan: 0°~360° Tilt: 0°~90° Rotate: 0°~360°	Pan: 0°~360° Tilt: 0°~90° Rotate: 0°~360°	Pan: 3°~360° Tilt: 0°~68° Rotate: 3°~360°
Sensor	1/2.8"/2MP/CMOS	1/2.8"/2MP/CMOS	1/3"/4MP/CMOS	1/3"/4MP/CMOS	1/3"/4MP/CMOS
Wide Dynamic Range	120dB True WDR	120dB True WDR	120dB True WDR	120dB True WDR	120dB True WDR
Zoom	Motorized	Motorized	Fixed	Fixed	Fixed
Lens	Focus: 2.7~13.5mm Iris: F1.2 Angle of view (H): 107.4°~ 29.2°	Focus: 2.7~13.5mm Iris: F1.2 Angle of view (H): 107.4°~ 29.2°	Focus: 2.8mm, 4mm Iris: F2.0 Angle of view (H): 107.8°/82.0°	Focus: 2.8mm, 4mm Iris: F1.6 Angle of view (H): 101.1°/83.7°	Focus: 2.8mm, 4mm Iris: F2.0 Angle of view (H): 107.8°/82.0°
Iris	Fixed	Fixed	Fixed	Fixed	Fixed
Min. illumination	Color: 0.0005Lux (F1.2, AGC ON) 0Lux with IR	Color: 0.0005Lux (F1.2, AGC ON) 0Lux with IR	Color: 0.01Lux (F2.0, AGC ON) 0Lux with IR	Color: 0.003Lux (F1.6, AGC ON) 0Lux with IR	Color: 0.01Lux (F2.0, AGC ON) 0Lux with IR
IR	Up to 40m (131ft)	Up to 40m (131ft)	Up to 30m (98ft)	Up to 40m (131ft)	Up to 30m (98ft)
Video Compression	Ultra 265, H.265, H.264, MJPEG	Ultra 265, H.265, H.264, MJPEG	Ultra 265, H.265, H.264, MJPEG	Ultra 265, H.265, H.264, MJPEG	Ultra 265, H.265, H.264, MJPEG
Smart Function	√	√	√	√	√
Frame Rate	1920*1080 30fps 1280*720 30fps	1920*1080 30fps 1280*720 30fps	2688*1520 30fps 2560*1440 30fps 2304*1296 30fps 1920*1080 30fps	2688*1520 25fps 2560*1440 25fps 2304*1296 25fps 1920*1080 30fps	2688*1520 30fps 2560*1440 30fps 2304*1296 30fps 1920*1080 30fps
ROI (Region of Interest)	√	√	√	√	√
9:16 Corridor Mode	√	√	N/A	√	N/A
Video Streaming	Triple streams	Triple streams	Triple streams	Triple streams	Triple streams
Privacy Mask	√	√	√	√	√
OSD font	vector	vector	lattice	vector	lattice
The number of OSD	Up to 8 OSDs	Up to 8 OSDs	Up to 4 OSDs	Up to 8 OSDs	Up to 4 OSDs
Audio I/O	1 / 1(Built-in Mic)	Built-in Mic	Built-in Mic	Built-in Mic	1 / 1
Alarm I/O	1 / 1	N/A	N/A	N/A	1 / 1
BNC	N/A	N/A	N/A	N/A	N/A
Edge Storage	MicroSD, up to 256GB	MicroSD, up to 256GB	MicroSD, up to 256GB	MicroSD, up to 256GB	MicroSD, up to 256GB
Network Interface	10M/100M Base-TX Ethernet	10M/100M Base-TX Ethernet	10M/100M Base-TX Ethernet	10M/100M Base-TX Ethernet	10M/100M Base-TX Ethernet
Reset Button	√	√	N/A	√	N/A
Power	DC 12V ±25% PoE (IEEE 802.3af)	DC 12V ±25% PoE (IEEE 802.3af)	DC 12V ±25% PoE (IEEE 802.3af)	DC 12V ±25% PoE (IEEE 802.3af)	DC 12V ±25% PoE (IEEE 802.3af)
Working Environment	-30°C ~ 60°C (-22°F ~ 140°F)	-30°C ~ 60°C (-22°F ~ 140°F)	-30°C ~ 60°C (-22°F ~ 140°F)	-30°C ~ 60°C (-22°F ~ 140°F)	-35°C ~ 60°C (-31°F ~ 140°F)
Ingress Protection	IP67	IP67	IP67	IP67	IP67
Vandal Resistant	IK10	IK10	N/A	N/A	IK10
Weight	0.97kg (2.14lb)	0.69kg (1.52lb)	0.45kg (0.99lb)	0.42kg(0.93lb)	0.45kg (0.99lb)
Power Consumption	Max 7.0W	Max 7.0W	Max 6.4W	Max 4.0W	Max 5.5W
Dimensions(L × W × H)	Φ 148.0 × 111.4mm (Φ 5.8" × 4.4")	Φ 129 × 110mm (Φ 5.1" × 4.3")	165×63.1×62.5mm(6.5" × 2.5" × 2.5")	155.9 × 63.1 × 62.7mm(6.1" × 2.5" × 2.5")	Φ 108.7 × 81.1mm (Φ 4.3" × 3.2")





Prime I

Model	IPC324SB-DF28(40)K-I0	IPC3614SR3-ADPF28(40)-F	IPC3614SB-ADF28(40)KM-I0	IPC314SB-ADF28K-I0	IPC314SB-ADF28K-M12-I0
Appearance					
Axis	3-Axis	3-Axis	3-Axis	3-Axis	3-Axis
Low illumination characteristics	LightHunter	Low-light	LightHunter	LightHunter	LightHunter
Adjustment angle	Pan: 3°~360° Tilt: 0°~68° Rotate: 3°~360°	Pan: 0°~360° Tilt: 0°~80° Rotate: 0°~360°	Pan: 0°~360° Tilt: 0°~75° Rotate: 0°~360°	Pan: 0°~90° Tilt: 0°~68° Rotate: 0°~360°	Pan: 0°~90° Tilt: 0°~68° Rotate: 0°~360°
Sensor	1/3"/4MP/CMOS	1/3"/4MP/CMOS	1/3"/4MP/CMOS	1/3"/4MP/CMOS	1/3"/4MP/CMOS
Wide Dynamic Range	120dB True WDR	120dB True WDR	120dB True WDR	120dB True WDR	120dB True WDR
Zoom	Fixed	Fixed	Fixed	Fixed	Fixed
Lens	Focus: 2.8mm, 4mm Iris: F1.6 Angle of view (H): 101.1°/83.7°	Focus: 2.8mm, 4mm Iris: F2.0 Angle of view (H): 107.8°/82.0°	Focus: 2.8mm, 4mm Iris: F1.6 Angle of view (H): 101.1°/83.7°	Focus: 2.8mm, 4mm Iris: F1.6 Angle of view (H): 101.1°/83.7°	Focus: 2.8mm, 4mm Iris: F1.6 Angle of view (H): 101.1°/83.7°
Iris	Fixed	Fixed	Fixed	Fixed	Fixed
Min. illumination	Color: 0.003Lux (F1.6, AGC ON) 0Lux with IR	Color: 0.01Lux (F2.0, AGC ON) 0Lux with IR	Color: 0.003Lux (F1.6, AGC ON) 0Lux with IR	Color: 0.003Lux (F1.6, AGC ON) 0Lux with IR	Color: 0.003Lux (F1.6, AGC ON) 0Lux with IR
IR	Up to 30m (98ft)	Up to 30m (98ft)	Up to 30m (98ft)	Up to 30m (98ft)	Up to 30m (98ft)
Video Compression	Ultra 265, H.265, H.264, MJPEG	Ultra 265, H.265, H.264, MJPEG	Ultra 265, H.265, H.264, MJPEG	Ultra 265, H.265, H.264, MJPEG	Ultra 265, H.265, H.264, MJPEG
Smart Function	√	√	√	√	√
Frame Rate	2688*1520 25fps 2560*1440 25fps 2304*1296 25fps 1920*1080 30fps	2688*1520 30fps 2560*1440 30fps 2304*1296 30fps 1920*1080 30fps	2688*1520 25fps 2560*1440 25fps 2304*1296 25fps 1920*1080 30fps	2688*1520 25fps 2560*1440 25fps 2304*1296 25fps 1920*1080 30fps	2688*1520 25fps 2560*1440 25fps 2304*1296 25fps 1920*1080 30fps
ROI (Region of Interest)	√	√	√	√	√
9:16 Corridor Mode	√	N/A	√	√	√
Video Streaming	Triple streams	Triple streams	Triple streams	Triple streams	Triple streams
Privacy Mask	√	√	√	√	√
OSD font	vector	lattice	vector	vector	vector
The number of OSD	Up to 8 OSDs	Up to 4 OSDs	Up to 8 OSDs	Up to 8 OSDs	Up to 8 OSDs
Audio I/O	1 / 1	Built-in Mic	Built-in Mic	1 / 1, Built-in Mic	1 / 1, Built-in Mic
Alarm I/O	1 / 1	N/A	N/A	N/A	N/A
BNC	N/A	N/A	N/A	N/A	N/A
Edge Storage	MicroSD, up to 256GB	MicroSD, up to 256G	MicroSD, up to 256GB	MicroSD, up to 256GB	MicroSD, up to 256GB
Network Interface	10M/100M Base-TX Ethernet	10M/100M Base-TX Ethernet	10M/100M Base-TX Ethernet	10M/100M Base-TX Ethernet	10M/100M Base-TX Ethernet
Reset Button	√	N/A	N/A	N/A	N/A
Power	DC 12V ±25% PoE (IEEE 802.3af)	DC 12V ±25% PoE (IEEE 802.3af)	DC 12V ±25% PoE (IEEE 802.3af)	DC 12V ±25% PoE (IEEE 802.3af)	DC 12V ±25%
Working Environment	-30°C ~ 60°C (-22°F ~ 140°F)	-30°C ~ 60°C (-22°F ~ 140°F)	-30°C ~ 60°C (-22°F ~ 140°F)	-30°C ~ 60°C (-22°F ~ 140°F)	-30°C ~ 60°C (-22°F ~ 140°F)
Ingress Protection	IP67	IP67	IP67	IP67	IP67
Vandal Resistant	IK10	N/A	N/A	IK10	IK10
Weight	0.42kg(0.93lb)	0.33kg(0.73lb)	0.42kg(0.93lb)	0.37kg(0.82lb)	0.37kg(0.82lb)
Power Consumption	Max 4.5W	Max 5.5W	Max 5.0W	Max 6.0W	Max 6.0W
Dimensions(L × W × H)	Φ108.7 x 81.1mm (Φ4.3" x 3.2")	Φ118x96mm (Φ4.6" x 3.8")	Φ110.5 x 94.1mm (Φ4.4" x 3.7")	Φ110 x 65mm (Φ4.3" x 2.4")	Φ110 x 65mm (Φ4.3" x 2.4")





Prime I

Model	IPC354SR3-ADNPF28-F	IPC2324SBR5-DPZ-F	IPC2324SB-DZK-I0	IPC3534SR3-DVPZ-F	IPC3534SR3-DVNPZ-F
Appearance					
Axis	3-Axis	3-Axis	3-Axis	3-Axis	3-Axis
Low illumination characteristics	Low-light	Low-light	LightHunter	Low-light	Low-light
Adjustment angle	Pan: 3°~360° Tilt: 0°~68° Rotate: 3°~360°	Pan: 0°~360° Tilt: 0°~90° Rotate: 0°~360°	Pan: 0°~360° Tilt: 0°~90° Rotate: 0°~360°	Pan: 0°~360° Tilt: 0°~70° Rotate: 0°~360°	Pan: 0°~360° Tilt: 0°~70° Rotate: 0°~360°
Sensor	1/3"/4MP/CMOS	1/3"/4MP/CMOS	1/3"/4MP/CMOS	1/3"/4MP/CMOS	1/3"/4MP/CMOS
Wide Dynamic Range	120dB True WDR	120dB True WDR	120dB True WDR	120dB True WDR	120dB True WDR
Zoom	Fixed	Motorized	Motorized	Motorized	Motorized
Lens	Focus: 2.8mm Iris: F2.0 Angle of view (H): 105.3°	Focus: 2.8~12mm Iris: F1.6 Angle of view (H): 98.26°~ 31.35°	Focus: 2.7~13.5mm Iris: F1.2 Angle of view (H): 98.26°~ 31.35°	Focus: 2.8~12mm Iris: F1.6 Angle of view (H): 98.26°~ 31.35°	Focus: 2.8~12mm Iris: F1.6 Angle of view (H): 98.26°~ 31.35°
Iris	Fixed	Fixed	Fixed	Fixed	Fixed
Min. illumination	Color: 0.01Lux (F2.0, AGC ON) 0Lux with IR	Color: 0.01Lux (F1.6, AGC ON) 0Lux with IR	Color: 0.002Lux (F1.2, AGC ON) 0Lux with IR	Color: 0.01Lux (F1.6, AGC ON) 0Lux with IR	Color: 0.01Lux (F1.6, AGC ON) 0Lux with IR
IR	Up to 30m (98ft)	Up to 50m (164ft)	Up to 50m (164ft)	Up to 30m (98ft)	Up to 30m (98ft)
Video Compression	Ultra 265, H.265, H.264, MJPEG	Ultra 265, H.265, H.264, MJPEG	Ultra 265, H.265, H.264, MJPEG	Ultra 265, H.265, H.264, MJPEG	Ultra 265, H.265, H.264, MJPEG
Smart Function	√	√	√	√	√
Frame Rate	2688*1520 30fps 2560*1440 30fps 2304*1296 30fps 1920*1080 30fps	2688*1520 30fps 2560*1440 30fps 2304*1296 30fps 1920*1080 30fps	2688*1520 25fps 2560*1440 25fps 2304*1296 25fps 1920*1080 30fps	2688*1520 30fps 2560*1440 30fps 2304*1296 30fps 1920*1080 30fps	2688*1520 30fps 2560*1440 30fps 2304*1296 30fps 1920*1080 30fps
ROI (Region of Interest)	√	√	√	√	√
9:16 Corridor Mode	N/A	N/A	√	N/A	N/A
Video Streaming	Triple streams	Triple streams	Triple streams	Triple streams	Triple streams
Privacy Mask	√	√	√	√	√
OSD font	lattice	lattice	vector	lattice	lattice
The number of OSD	Up to 4 OSDs	Up to 4 OSDs	Up to 8 OSDs	Up to 4 OSDs	Up to 4 OSDs
Audio I/O	1 / 1	1 / 1	1 / 1	1 / 1	1 / 1
Alarm I/O	1 / 1	1 / 1	1 / 1	1 / 1	1 / 1
BNC	N/A	N/A	N/A	N/A	N/A
Edge Storage	MicoSD, up to 256G	MicoSD, up to 256G	MicroSD, up to 256GB	MicoSD, up to 256G	MicoSD, up to 256G
Network Interface	10M/100M Base-TX Ethernet	10M/100M Base-TX Ethernet	10M/100M Base-TX Ethernet	10M/100M Base-TX Ethernet	10M/100M Base-TX Ethernet
Reset Button	√	N/A	N/A	√	√
Power	DC 12V ±25% PoE (IEEE 802.3af)	DC 12V ±25% PoE (IEEE 802.3af)	DC 12V ±25% PoE (IEEE 802.3af)	DC 12V ±25% PoE (IEEE 802.3af)	DC 12V ±25% PoE (IEEE 802.3af)
Working Environment	-35°C ~ 60°C (-31°F ~ 140°F)	-30°C ~ 60°C (-22°F ~ 140°F)	-30°C ~ 60°C (-22°F ~ 140°F)	-35°C ~ 60°C (-31°F ~ 140°F)	-35°C ~ 60°C (-31°F ~ 140°F)
Ingress Protection	N/A	IP67	IP67	IP67	IP66
Vandal Resistant	N/A	N/A	IK10	IK10	IK10
Weight	0.22kg(0.49lb)	1kg(2.2lb)	0.92kg(2.03lb)	0.57kg(1.26lb)	0.57kg(1.26lb)
Power Consumption	Max 5.5W	Max 9.5W	Max 8.5W	Max 8.7W	Max 8.7W
Dimensions(L × W × H)	Φ108.5 x 61.6mm (Φ4.28" x 2.43")	240.3 x 86.4 x 75.6mm (9.5" x 3.4" x 3.0")	245.4 x 85.4 x 86.4mm(9.7" x 3.4" x 3.4")	Φ128.1mmx99.9mm (Φ5.04" x 3.93")	Φ128.1mmx99.9mm (Φ5.04" x 3.93")





Prime I

Model	IPC3234SB-ADZK-I0	IPC3634SR3-ADPZ-F	IPC3634SB-ADZK-I0	IPC2125SR3-ADPF28(40)M-F
Appearance				
Axis	3-Axis	3-Axis	3-Axis	3-Axis
Low illumination characteristics	LightHunter	Low-light	LightHunter	Low-light
Adjustment angle	Pan: 0°~355° Tilt: 0°~80° Rotate: 0°~355°	Pan: 0°~360° Tilt: 0°~90° Rotate: 0°~360°	Pan: 0°~360° Tilt: 0°~75° Rotate: 0°~360°	Pan: 0°~360° Tilt: 0°~90° Rotate: 0°~360°
Sensor	1/3"4MP/CMOS	1/3"4MP/CMOS	1/3"4MP/CMOS	1/2.7"5MP/CMOS
Wide Dynamic Range	120dB True WDR	120dB True WDR	120dB True WDR	120dB True WDR
Zoom	Motorized	Motorized	Motorized	Fixed
Lens	Focus: 2.7~13.5mm Iris: F1.2 Angle of view (H): 98.26°~ 31.35°	Focus: 2.8~12mm Iris: F1.6 Angle of view(H): 98.26°~ 31.35°	Focus: 2.7~13.5mm Iris: F2.0 Angle of view (H): 98.26°~ 31.35°	Focus: 2.8mm, 4mm Iris: F2.0 Angle of view (H): 105.6°/80.0°
Iris	Fixed	Fixed	Fixed	Fixed
Min. illumination	Color: 0.002Lux (F1.2, AGC ON) 0Lux with IR	Color: 0.01Lux (F1.6, AGC ON) 0Lux with IR	Color: 0.002Lux (F1.2, AGC ON) 0Lux with IR	Color: 0.01Lux (F2.0, AGC ON) 0Lux with IR
IR	Up to 40m (131ft)	Up to 30m (98ft)	Up to 40m (131ft)	Up to 30m (98ft)
Video Compression	Ultra 265, H.265, H.264, MJPEG	Ultra 265, H.265, H.264, MJPEG	Ultra 265, H.265, H.264, MJPEG	Ultra 265, H.265, H.264, MJPEG
Smart Function	√	√	√	√
Frame Rate	2688*1520 25fps 2560*1440 25fps 2304*1296 25fps 1920*1080 30fps	2688*1520 25fps 2560*1440 30fps 2304*1296 30fps 1920*1080 30fps	2688*1520 25fps 2560*1440 25fps 2304*1296 25fps 1920*1080 30fps	2592*1944 20fps 2560*1440 25fps 2304*1296 30fps 1920*1080 30fps
ROI (Region of Interest)	√	√	√	√
9:16 Corridor Mode	√	N/A	√	N/A
Video Streaming	Triple streams	Triple streams	Triple streams	Triple streams
Privacy Mask	√	√	√	√
OSD font	vector	lattice	vector	lattice
The number of OSD	Up to 8 OSDs	Up to 4 OSDs	Up to 8 OSDs	Up to 4 OSDs
Audio I/O	1 / 1(Built-in Mic)	Built-in Mic	Built-in Mic	Built-in Mic
Alarm I/O	1 / 1	N/A	N/A	N/A
BNC	N/A	N/A	N/A	N/A
Edge Storage	MicroSD, up to 256GB	MicoSD, up to 256G	MicroSD, up to 256GB	MicroSD, up to 256GB
Network Interface	10M/100M Base-TX Ethernet	10M/100M Base-TX Ethernet	10M/100M Base-TX Ethernet	10M/100M Base-TX Ethernet
Reset Button	√	√	√	N/A
Power	DC 12V ±25% PoE (IEEE 802.3af)	DC 12V ±25% PoE (IEEE 802.3af)	DC 12V ±25% PoE (IEEE 802.3af)	DC 12V ±25% PoE (IEEE 802.3af)
Working Environment	-30°C ~ 60°C (-22°F ~ 140°F)	-40°C ~ 60°C (-40°F ~ 140°F)	-30°C ~ 60°C (-22°F ~ 140°F)	-30°C ~ 60°C (-22°F ~ 140°F)
Ingress Protection	IP67	IP67	IP67	IP67
Vandal Resistant	IK10	N/A	IK10	N/A
Weight	0.92kg (2.03lb)	0.67kg (1.48lb)	0.69kg (1.52lb)	0.45kg (0.99lb)
Power Consumption	Max 7.0W	Max 8.16W	Max 7.0W	Max 6.4W
Dimensions(L × W × H)	Φ 148.0 x 111.4mm (Φ5.8" x 4.4")	Φ 129 x 110mm (Φ5.1" x 4.3")	Φ 129 x 110mm (Φ5.1" x 4.3")	165×63.1×62.5mm(6.5" × 2.5" × 2.5")





Prime I

Model	IPC2125SB-ADF28(40)KM-I0	IPC325SR3-DVPF28(40)-F	IPC325SB-DF28(40)K-I0	IPC3615SR3-ADPF28(40)-F
Appearance				
Axis	3-Axis	3-Axis	3-Axis	3-Axis
Low illumination characteristics	LightHunter	Low-light	LightHunter	Low-light
Adjustment angle	Pan: 0°~360° Tilt: 0°~90° Rotate: 0°~360°	Pan: 3°~360° Tilt: 0°~68° Rotate: 3°~360°	Pan: 3°~360° Tilt: 0°~68° Rotate: 3°~360°	Pan: 0°~360° Tilt: 0°~80° Rotate: 0°~360°
Sensor	1/2.7"5MP/CMOS	1/2.7"5MP/CMOS	1/2.7"5MP/CMOS	1/2.7"5MP/CMOS
Wide Dynamic Range	120dB True WDR	120dB True WDR	120dB True WDR	120dB True WDR
Zoom	Fixed	Fixed	Fixed	Fixed
Lens	Focus: 2.8mm, 4mm Iris: F1.6 Angle of view (H): 112.7°/86.5°	Focus: 2.8mm, 4mm Iris: F2.0 Angle of view (H): 105.6°/80.0°	Focus: 2.8mm, 4mm Iris: F1.6 Angle of view (H): 112.7°/86.5°	Focus: 2.8mm, 4mm Iris: F2.0 Angle of view (H): 105.6°/80.0°
Iris	Fixed	Fixed	Fixed	Fixed
Min. illumination	Color: 0.003Lux (F1.6, AGC ON) 0Lux with IR	Color: 0.01Lux (F2.0, AGC ON) 0Lux with IR	Color: 0.003Lux (F1.6, AGC ON) 0Lux with IR	Color: 0.01Lux (F2.0, AGC ON) 0Lux with IR
IR	Up to 40m (131ft)	Up to 30m (98ft)	Up to 30m (98ft)	Up to 30m (98ft)
Video Compression	Ultra 265, H.265, H.264, MJPEG	Ultra 265, H.265, H.264, MJPEG	Ultra 265, H.265, H.264, MJPEG	Ultra 265, H.265, H.264, MJPEG
Smart Function	√	√	√	√
Frame Rate	2880*1620 25fps 2560*1440 25fps 2304*1296 25fps 1920*1080 30fps	2592*1944 20fps 2560*1440 25fps 2304*1296 30fps 1920*1080 30fps	2880*1620 25fps 2560*1440 25fps 2304*1296 25fps 1920*1080 30fps	2592*1944 20fps 2560*1440 30fps 2304*1296 30fps 1920*1080 30fps
ROI (Region of Interest)	√	√	√	√
9:16 Corridor Mode	√	N/A	√	N/A
Video Streaming	Triple streams	Triple streams	Triple streams	Triple streams
Privacy Mask	√	√	√	√
OSD font	vector	lattice	vector	lattice
The number of OSD	Up to 8 OSDs	Up to 4 OSDs	Up to 8 OSDs	Up to 4 OSDs
Audio I/O	Built-in Mic	1 / 1	1 / 1	Built-in Mic
Alarm I/O	N/A	1 / 1	1 / 1	N/A
BNC	N/A	N/A	N/A	N/A
Edge Storage	MicroSD, up to 256GB	MicoSD, up to 256G	MicroSD, up to 256GB	MicoSD, up to 256G
Network Interface	10M/100M Base-TX Ethernet	10M/100M Base-TX Ethernet	10M/100M Base-TX Ethernet	10M/100M Base-TX Ethernet
Reset Button	√	N/A	N/A	N/A
Power	DC 12V ±25% PoE (IEEE 802.3af)	DC 12V ±25% PoE (IEEE 802.3af)	DC 12V ±25% PoE (IEEE 802.3af)	DC 12V ±25% PoE (IEEE 802.3af)
Working Environment	-30°C ~ 60°C (-22°F ~ 140°F)	-35°C ~ 60°C (-31°F ~ 140°F)	-30°C ~ 60°C (-22°F ~ 140°F)	-30°C ~ 60°C (-22°F ~ 140°F)
Ingress Protection	IP67	IP67	IP67	IP67
Vandal Resistant	N/A	IK10	IK10	N/A
Weight	0.425kg (0.93lb)	0.45kg (0.99lb)	0.425kg (0.93lb)	0.33kg (0.73lb)
Power Consumption	Max 5.0W	Max 5.5W	Max 4.5W	Max 5.5W
Dimensions(L × W × H)	155.9 × 63.1 × 62.7mm (6.1" × 2.5" × 2.5")	Φ 108.7 × 81.1mm (Φ 4.3" × 3.2")	Φ 108.7 × 81.1mm (Φ 4.3" × 3.2")	Φ 118x96mm (Φ 4.6"x3.8")





Prime I

Model	IPC3615SB-ADF28(40)KM-I0	IPC2325SBR5-DPZ-F	IPC2325SB-DZK-I0	IPC3535SR3-DVPZ-F
Appearance				
Axis	3-Axis	3-Axis	3-Axis	3-Axis
Low illumination characteristics	LightHunter	Low-light	LightHunter	Low-light
Adjustment angle	Pan: 0°~360° Tilt: 0°~80° Rotate: 0°~360°	Pan: 0°~360° Tilt: 0°~90° Rotate: 0°~360°	Pan: 0°~360° Tilt: 0°~90° Rotate: 0°~360°	Pan: 0°~360° Tilt: 0°~70° Rotate: 0°~360°
Sensor	1/2.7"/5MP/CMOS	1/2.7"/5MP/CMOS	1/2.7"/5MP/CMOS	1/2.7"/5MP/CMOS
Wide Dynamic Range	120dB True WDR	120dB True WDR	120dB True WDR	120dB True WDR
Zoom	Fixed	Motorized	Motorized	Motorized
Lens	Focus: 2.8mm, 4mm Iris: F1.6 Angle of view (H): 112.7°/86.5°	Focus: 2.8~12mm Iris: F1.6 Angle of view(H): 96.23°~ 31.69°	Focus: 2.7~13.5mm Iris: F1.2 Angle of view (H): 106.25°~ 30.42°	Focus: 2.8~12mm Iris: F1.6 Angle of view(H): 96.23°~ 31.69°
Iris	Fixed	Fixed	Fixed	Fixed
Min. illumination	Color: 0.003Lux (F1.6, AGC ON) 0Lux with IR	Color: 0.01Lux (F1.6, AGC ON) 0Lux with IR	Color: 0.002Lux (F1.2, AGC ON) 0Lux with IR	Color: 0.01Lux (F1.6, AGC ON) 0Lux with IR
IR	Up to 30m (98ft)	Up to 50m (164ft)	Up to 50m (164ft)	Up to 30m (98ft)
Video Compression	Ultra 265, H.265, H.264, MJPEG	Ultra 265, H.265, H.264, MJPEG	Ultra 265, H.265, H.264, MJPEG	Ultra 265, H.265, H.264, MJPEG
Smart Function	√	√	√	√
Frame Rate	2880*1620 25fps 2560*1440 25fps 2304*1296 25fps 1920*1080 30fps;	2592*1944 20fps 2560*1440 30fps 2304*1296 30fps 1920*1080 30fps	2880*1620 25fps 2560*1440 25fps 2304*1296 25fps 1920*1080 30fps	2592*1944 20fps 2560*1440 25fps 2304*1296 25fps 1920*1080 30fps
ROI (Region of Interest)	√	√	√	√
9:16 Corridor Mode	√	N/A	√	N/A
Video Streaming	Triple streams	Triple streams	Triple streams	Triple streams
Privacy Mask	√	√	√	√
OSD font	vector	lattice	vector	lattice
The number of OSD	Up to 8 OSDs	Up to 4 OSDs	Up to 8 OSDs	Up to 4 OSDs
Audio I/O	Built-in Mic	1 / 1	1 / 1	1 / 1
Alarm I/O	N/A	1 / 1	1 / 1	1 / 1
BNC	N/A	N/A	N/A	N/A
Edge Storage	MicroSD, up to 256GB	MicoSD, up to 256G	MicroSD, up to 256GB	MicroSD, up to 256G
Network Interface	10M/100M Base-TX Ethernet	10M/100M Base-TX Ethernet	10M/100M Base-TX Ethernet	10M/100M Base-TX Ethernet
Reset Button	N/A	N/A	N/A	√
Power	DC 12V ±25% PoE (IEEE 802.3af)	DC 12V ±25% PoE (IEEE 802.3af)	DC 12V ±25% PoE (IEEE 802.3af)	DC 12V ±25% PoE (IEEE 802.3af)
Working Environment	-30°C ~ 60°C (-22°F ~ 140°F)	-30°C ~ 60°C (-22°F ~ 140°F)	-30°C ~ 60°C (-22°F ~ 140°F)	-35°C ~ 60°C (-31°F ~ 140°F)
Ingress Protection	IP67	IP67	IP67	IP67
Vandal Resistant	N/A	N/A	IK10	IK10
Weight	0.425kg (0.93lb)	1kg (2.2lb)	0.92kg (2.03lb)	0.57kg (1.26lb)
Power Consumption	Max 4.0W	Max 9.5W	Max 8.0W	Max 8.7W
Dimensions(L × W × H)	Φ 110.5 × 94.1mm (Φ 4.4" × 3.7")	240.3 × 86.4 × 75.6mm (9.5" × 3.4" × 3.0")	245 × 86 × 72mm (9.6" × 3.4" × 2.8")	Φ 128.1mm×99.9mm (Φ 5.04" × 3.93")





Prime I

Model	IPC3235SB-ADZK-I0	IPC3635SR3-ADPZ-F	IPC3635SB-ADZK-I0	IPC2128SB-ADF28(40)KMC-I0
Appearance				
Axis	3-Axis	3-Axis	3-Axis	3-Axis
Low illumination characteristics	LightHunter	Low-light	LightHunter	Low-light
Adjustment angle	Pan: 0°~355° Tilt: 0°~80° Rotate: 0°~355°	Pan: 0°~360° Tilt: 0°~90° Rotate: 0°~360°	Pan: 0°~360° Tilt: 0°~75° Rotate: 0°~360°	Pan: 0°~360° Tilt: 0°~90° Rotate: 0°~360°
Sensor	1/2.7"/5MP/CMOS	1/2.7"/5MP/CMOS	1/2.7"/5MP/CMOS	1/2.7"/8MP/CMOS
Wide Dynamic Range	120dB True WDR	120dB True WDR	120dB True WDR	120dB True WDR
Zoom	Motorized	Motorized	Motorized	Fixed
Lens	Focus: 2.7~13.5mm Iris: F1.2 Angle of view (H):106.25°~ 30.42°	Focus: 2.8~12mm Iris: F1.6 Angle of view(H): 96.23°~ 31.69°	Focus: 2.7~13.5mm Iris: F1.2 Angle of view (H):106.25°~ 30.42°	Focus: 2.8mm, 4mm Iris: F2.0 Angle of view (H): 112.4°/86.5°
Iris	Fixed	Fixed	Fixed	Fixed
Min. illumination	Color: 0.002Lux (F1.2, AGC ON) 0Lux with IR	Color: 0.01Lux (F1.6, AGC ON) 0Lux with IR	Color: 0.002Lux (F1.2, AGC ON) 0Lux with IR	Color: 0.01Lux (F2.0, AGC ON) 0Lux with IR
IR	Up to 40m (131ft)	Up to 30m (98ft)	Up to 40m (131ft)	Up to 30m (98ft)
Video Compression	Ultra 265, H.265, H.264, MJPEG	Ultra 265, H.265, H.264, MJPEG	Ultra 265, H.265, H.264, MJPEG	Ultra 265, H.265, H.264, MJPEG
Smart Function	√	√	√	√
Frame Rate	2880*1620 25fps 2560*1440 25fps 2304*1296 25fps 1920*1080 30fps	2592*1944 20fps 2560*1440 30fps 2304*1296 30fps 1920*1080 30fps	2880*1620 25fps 2560*1440 25fps 2304*1296 25fps 1920*1080 30fps	3840*2160 20fps 3072*1728 30fps 2560*1440 30fps 1920*1080 30fps
ROI (Region of Interest)	√	√	√	√
9:16 Corridor Mode	√	N/A	√	√
Video Streaming	Triple streams	Triple streams	Triple streams	Triple streams
Privacy Mask	√	√	√	√
OSD font	vector	lattice	vector	vector
The number of OSD	Up to 8 OSDs	Up to 4 OSDs	Up to 8 OSDs	Up to 8 OSDs
Audio I/O	1 / 1 (Built-in Mic)	Built-in Mic	Built-in Mic	Built-in Mic, Built-in Speaker
Alarm I/O	1 / 1	N/A	N/A	N/A
BNC	N/A	N/A	N/A	N/A
Edge Storage	MicroSD, up to 256GB	MicoSD, up to 256G	MicroSD, up to 256GB	MicroSD, up to 256GB
Network Interface	10M/100M Base-TX Ethernet	10M/100M Base-TX Ethernet	10M/100M Base-TX Ethernet	10M/100M Base-TX Ethernet
Reset Button	√	√	√	√
Power	DC 12V ±25% PoE (IEEE 802.3af)	DC 12V ±25% PoE (IEEE 802.3af)	DC 12V ±25% PoE (IEEE 802.3af)	DC 12V ±25% PoE (IEEE 802.3af)
Working Environment	-30°C ~ 60°C (-22°F ~ 140°F)	-40°C ~ 60°C (-40°F ~ 140°F)	-30°C ~ 60°C (-22°F ~ 140°F)	-30°C ~ 60°C (-22°F ~ 140°F)
Ingress Protection	IP67	IP67	IP67	IP67
Vandal Resistant	IK10	N/A	IK10	N/A
Weight	0.97kg (2.12lb)	0.67kg (1.48lb)	0.70kg (1.52lb)	0.41kg (0.90lb)
Power Consumption	Max 7.0W	Max 8.16W	Max 7.0W	Max 10.5W
Dimensions(L × W × H)	Φ 148.0 × 111.4mm (Φ 5.8" × 4.4")	Φ 129 × 110mm (Φ 5.1" × 4.3")	Φ 129 × 110mm (Φ 5.1" × 4.3")	191 × 75 × 74mm (7.5" × 3.0" × 2.9")

Prime I

Model	IPC3618SB-ADF28(40)KM-I0	IPC2328SB-DZK-I0	IPC3238SB-ADZK-I0	IPC3638SB-ADZK-I0
Appearance				
Axis	3-Axis	3-Axis	3-Axis	3-Axis
Low illumination characteristics	Low-light	LightHunter	LightHunter	LightHunter
Adjustment angle	Pan: 3°~360° Tilt: 0°~80° Rotate: 3°~360°	Pan: 0°~360° Tilt: 0°~90° Rotate: 0°~360°	Pan: 0°~355° Tilt: 0°~80° Rotate: 0°~355°	Pan: 0°~360° Tilt: 0°~75° Rotate: 0°~360°
Sensor	1/2.7"/8MP/CMOS	1/2.8"/8MP/CMOS	1/2.8"/8MP/CMOS	1/2.8"/8MP/CMOS
Wide Dynamic Range	120dB True WDR	120dB True WDR	120dB True WDR	120dB True WDR
Zoom	Fixed	Motorized	Motorized	Motorized
Lens	Focus: 2.8mm, 4mm Iris: F2.0 Angle of view (H): 112.4°/86.5°	Focus: 2.8~12mm Iris: F1.6 Angle of view (H): 107.4°~29.2°	Focus: 2.8~12mm Iris: F1.6 Angle of view (H): 107.4°~29.2°	Focus: 2.8~12mm Iris: F1.6 Angle of view (H): 107.4°~29.2°
Iris	Fixed	Fixed	Fixed	Fixed
Min. illumination	Color: 0.01Lux (F2.0, AGC ON) 0Lux with IR	Color: 0.003Lux (F1.6, AGC ON) 0Lux with IR	Color: 0.003Lux (F1.6, AGC ON) 0Lux with IR	Color: 0.003Lux (F1.6, AGC ON) 0Lux with IR
IR	Up to 30m (98ft)	Up to 50m (164ft)	Up to 40m (131ft)	Up to 40m (131ft)
Video Compression	Ultra 265, H.265, H.264, MJPEG	Ultra 265, H.265, H.264, MJPEG	Ultra 265, H.265, H.264, MJPEG	Ultra 265, H.265, H.264, MJPEG
Smart Function	√	√	√	√
Frame Rate	3840*2160 20fps 3072*1728 30fps 2560*1440 30fps 1920*1080 30fps	3840*2160 20fps 3072*1728 30fps 2560*1440 30fps 1920*1080 30fps	3840*2160 20fps 3072*1728 30fps 2560*1440 30fps 1920*1080 30fps	3840*2160 20fps 3072*1728 30fps 2560*1440 30fps 1920*1080 30fps
ROI (Region of Interest)	√	√	√	√
9:16 Corridor Mode	√	√	√	√
Video Streaming	Triple streams	Triple streams	Triple streams	Triple streams
Privacy Mask	√	√	√	√
OSD font	vector	vector	vector	vector
The number of OSD	Up to 8 OSDs	Up to 8 OSDs	Up to 8 OSDs	Up to 8 OSDs
Audio I/O	Built-in Mic	1 / 1	1 / 1 (Built-in Mic)	Built-in Mic
Alarm I/O	N/A	1 / 1	1 / 1	N/A
BNC	N/A	N/A	N/A	N/A
Edge Storage	MicroSD, up to 256GB	MicroSD, up to 256GB	MicroSD, up to 256GB	MicroSD, up to 256GB
Network Interface	10M/100M Base-TX Ethernet	10M/100M Base-TX Ethernet	10M/100M Base-TX Ethernet	10M/100M Base-TX Ethernet
Reset Button	N/A	N/A	√	√
Power	DC 12V ±25% PoE (IEEE 802.3af)	DC 12V ±25% PoE (IEEE 802.3af)	DC 12V ±25% PoE (IEEE 802.3af)	DC 12V ±25% PoE (IEEE 802.3af)
Working Environment	-30°C ~ 60°C (-22°F ~ 140°F)	-30°C ~ 60°C (-22°F ~ 140°F)	-30°C ~ 60°C (-22°F ~ 140°F)	-30°C ~ 60°C (-22°F ~ 140°F)
Ingress Protection	IP67	IP67	IP67	IP67
Vandal Resistant	N/A	IK10	IK10	IK10
Weight	0.44kg (0.97lb)	0.92kg (2.03lb)	0.97kg (2.12lb)	0.69kg (1.52lb)
Power Consumption	Max 5.0W	Max 10.5W	Max 9.0W	Max 9.0W
Dimensions(L x W x H)	Φ 110.5 x 94.1mm (Φ 4.4" x 3.7")	245 x 86 x 72mm (9.6" x 3.4" x 2.8")	Φ 148.0 x 111.4mm (Φ 5.8" x 4.4")	Φ 129 x 110mm (Φ 5.1" x 4.3")





Prime II

Model	IPC2124SS-ADF28(40)KM	IPC2224SS-DF40(60)K	IPC324SS-DF28(40)K	IPC3614SS-ADF28(40)KM
Appearance				
Axis	3-Axis	3-Axis	3-Axis	3-Axis
Low illumination characteristics	LightHunter	LightHunter	LightHunter	LightHunter
Adjustment angle	Pan: 0°~360° Tilt: 0°~90° Rotate: 0°~360°	Pan: 0°~360° Tilt: 0°~90° Rotate: 0°~360°	Pan: 0°~360° Tilt: 0°~68° Rotate: 0°~360°	Pan: 0°~360° Tilt: 0°~90° Rotate: 0°~360°
Sensor	1/3"/4MP/CMOS	1/3"/4MP/CMOS	1/3"/4MP/CMOS	1/3"/4MP/CMOS
Wide Dynamic Range	120dB True WDR	120dB True WDR	120dB True WDR	120dB True WDR
Zoom	Fixed	Fixed	Fixed	Fixed
Lens	Focus: 2.8mm, 4mm Iris: F1.6 Angle of view(H): 107.8°/82°	Focus: 4mm, 6mm Iris: F1.6 Angle of view(H): 82°/52.1°	Focus: 2.8mm, 4mm Iris: F1.6 Angle of view(H): 107.8°/82°	Focus: 2.8mm, 4mm Iris: F1.6 Angle of view(H): 107.8°/82°
Iris	Fixed	Fixed	Fixed	Fixed
Min. illumination	Colour: 0.003Lux (F1.6, AGC ON) 0Lux with IR	Colour: 0.003Lux (F1.6, AGC ON) 0Lux with IR	Colour: 0.003Lux (F1.6, AGC ON) 0Lux with IR	Colour: 0.003Lux (F1.6, AGC ON) 0Lux with IR
IR	Up to 40m (131ft)	Up to 60m (196ft)	Up to 40m (131ft)	Up to 40m (131ft)
Video Compression	Ultra 265, H.265, H.264, MJPEG	Ultra 265, H.265, H.264, MJPEG	Ultra 265, H.265, H.264, MJPEG	Ultra 265, H.265, H.264, MJPEG
Smart Function	√	√	√	√
Frame Rate	2688*1520, 30fps 2560*1440, 30fps 2304*1296, 30fps 1920*1080, 30fps	2688*1520, 30fps 2560*1440, 30fps 2304*1296, 30fps 1920*1080, 30fps	2688*1520, 30fps 2560*1440, 30fps 2304*1296, 30fps 1920*1080, 30fps	2688*1520, 30fps 2560*1440, 30fps 2304*1296, 30fps 1920*1080, 30fps
ROI (Region of Interest)	√	√	√	√
9:16 Corridor Mode	√	√	√	√
Video Streaming	Triple streams	Triple Streams	Triple Streams	Triple Streams
Privacy Mask	√	√	√	√
OSD font	vector	vector	vector	vector
The number of OSD	Up to 8 OSDs	Up to 8 OSDs	Up to 8 OSDs	Up to 8 OSDs
Audio I/O	Built-in Mic	1 / 1	1 / 1	Built-in Mic
Alarm I/O	N/A	1 / 1	1 / 1	N/A
BNC	N/A	N/A	N/A	N/A
Edge Storage	MicroSD, up to 128GB	MicroSD, up to 128GB	MicroSD, up to 128GB	MicroSD, up to 128GB
Network Interface	10M/100M Base-TX Ethernet	10M/100M Base-TX Ethernet	10M/100M Base-TX Ethernet	10M/100M Base-TX Ethernet
Reset Button	√	N/A	N/A	N/A
Power	DC 12V ±25% PoE (IEEE 802.3af)	DC 12V ±25% PoE (IEEE 802.3af)	DC 12V ±25% PoE (IEEE 802.3af)	DC 12V ±25% PoE (IEEE 802.3af)
Working Environment	-35°C ~ 60°C (-31°F ~ 140°F)	-35°C ~ 60°C (-31°F ~ 140°F)	-35°C ~ 60°C (-31°F ~ 140°F)	-30°C ~ 60°C (-22°F ~ 140°F)
Ingress Protection	IP67	IP67	IP67	IP67
Vandal Resistant	N/A	IK10	IK10	N/A
Weight	0.43kg (0.94lb)	0.87kg (1.91lb)	0.43kg (0.94lb)	0.43kg (0.94lb)
Power Consumption	Max 5.0W	Max 6.5W	Max 4.5W	Max 4.0W
Dimensions(L x W x H)	155.9*63.1*62.7mm(6.1"×2.5"×2.5")	245.4 x 86.4 x 85.4mm (9.7" x 3.4" x 3.4")	Φ 108.7 x 81.1mm (Φ 4.3" x 3.2")	Φ 110.5 x 94.1mm (Φ 4.4" x 3.7")

Prime II

Model	IPC2324SS-DZK	IPC3234SS-DZK	IPC3634SS-ADZK
Appearance			
Axis	3-Axis	3-Axis	3-Axis
Low illumination characteristics	LightHunter	LightHunter	LightHunter
Adjustment angle	Pan: 0°~360° Tilt: 0°~90° Rotate: 0°~360°	Pan: 0°~360° Tilt: 0°~90° Rotate: 0°~360°	Pan: 0°~360° Tilt: 0°~90° Rotate: 0°~360°
Sensor	1/3"/4MP/CMOS	1/3"/4MP/CMOS	1/3"/4MP/CMOS
Wide Dynamic Range	120dB True WDR	120dB True WDR	120dB True WDR
Zoom	Motorized	Motorized	Motorized
Lens	Focus: 2.7 ~ 13.5mm Iris: F1.35 Angle of view(H): 100.1° ~ 28.6°	Focus: 2.7 ~ 13.5mm Iris: F1.35 Angle of view(H): 100.1° ~ 28.6°	Focus: 2.7 ~ 13.5mm Iris: F1.35 Angle of view(H): 100.1° ~ 28.6°
Iris	Fixed	Fixed	Fixed
Min. illumination	Colour: 0.002Lux (F1.35, AGC ON) 0Lux with IR	Colour: 0.002Lux (F1.35, AGC ON) 0Lux with IR	Colour: 0.002Lux (F1.35, AGC ON) 0Lux with IR
IR	Up to 50m (164ft)	Up to 40m (131ft)	Up to 40m (131ft)
Video Compression	Ultra 265, H.265, H.264, MJPEG	Ultra 265, H.265, H.264, MJPEG	Ultra 265, H.265, H.264, MJPEG
Smart Function	√	√	√
Frame Rate	2688*1520, 30fps 2560*1440, 30fps 2304*1296, 30fps 1920*1080, 30fps	2688*1520, 30fps 2560*1440, 30fps 2304*1296, 30fps 1920*1080, 30fps	2688*1520, 30fps 2560*1440, 30fps 2304*1296, 30fps 1920*1080, 30fps
ROI (Region of Interest)	√	√	√
9:16 Corridor Mode	√	√	√
Video Streaming	Triple Streams	Triple Streams	Triple Streams
Privacy Mask	√	√	√
OSD font	vector	vector	vector
The number of OSD	Up to 8 OSDs	Up to 8 OSDs	Up to 8 OSDs
Audio I/O	1 / 1	1 / 1	Built-in Mic
Alarm I/O	1 / 1	1 / 1	N/A
BNC	N/A	N/A	N/A
Edge Storage	MicroSD, up to 128GB	MicroSD, up to 128GB	MicroSD, up to 128GB
Network Interface	10M/100M Base-TX Ethernet	10M/100M Base-TX Ethernet	10M/100M Base-TX Ethernet
Reset Button	N/A	√	√
Power	DC 12V ±25% PoE (IEEE 802.3af)	DC 12V ±25% PoE (IEEE 802.3af)	DC 12V ±25% PoE (IEEE 802.3af)
Working Environment	-35°C ~ 60°C (-31°F ~ 140°F)	-35°C ~ 60°C (-31°F ~ 140°F)	-35°C ~ 60°C (-31°F ~ 140°F)
Ingress Protection	IP67	IP67	IP67
Vandal Resistant	IK10	IK10	IK10
Weight	0.93kg (2.0lb)	0.93kg (2.0lb)	0.69kg (1.52lb)
Power Consumption	Max 8.5W	Max 7.5W	Max 7.0W
Dimensions(L × W × H)	245.4 × 85.4 × 86.4mm (9.7" × 3.4" × 3.4")	Φ 148 × 111.3mm (Φ 5.8" × 4.4")	Φ 129.1 × 111.2mm (Φ 5.0" × 4.4")

Prime III

Model	IPC2225SE-DF40(60)K-WL-I0	IPC3615SE-ADF28(40)KM-WL-I0
Appearance	 	 
Axis	3-Axis	3-Axis
Low illumination characteristics	ColorHunter	ColorHunter
Adjustment angle	Pan: 0°~360° Tilt: 0°~90° Rotate: 0°~360°	Pan: 3°~360° Tilt: 0°~80° Rotate: 3°~360°
Sensor	1/2.7"/5MP/CMOS	1/2.7"/5MP/CMOS
Wide Dynamic Range	120dB True WDR	120dB True WDR
Zoom	Fixed	Fixed
Lens	Focus: 4.0mm, 6.0mm Iris: F1.0 Angle of view (H): 80.2°/53.4°	Focus: 2.8mm, 4.0mm Iris: F1.0 Angle of view (H): 102.0°/80.2°
Iris	Fixed	Fixed
Min. illumination	Color: 0.001Lux (F1.0, AGC ON) 0Lux with IR	Color: 0.001Lux (F1.0, AGC ON) 0Lux with IR
IR	Up to 30m (98ft)	Up to 30m (98ft)
Video Compression	Ultra 265, H.265, H.264, MJPEG	Ultra 265, H.265, H.264, MJPEG
Smart Function	√	√
Frame Rate	2880x1620 25fps 2560x1440 25fps 2304x1296 25fps 1920x1080 30fps	2880x1620 25fps 2560x1440 25fps 2304x1296 25fps 1920x1080 30fps
ROI (Region of Interest)	√	√
9:16 Corridor Mode	√	√
Video Streaming	Triple streams	Triple streams
Privacy Mask	√	√
OSD font	vector	vector
The number of OSD	Up to 8 OSDs	Up to 8 OSDs
Audio I/O	1 / 1	Built-in Mic
Alarm I/O	1 / 1	N/A
BNC	N/A	N/A
Edge Storage	MicroSD, up to 256GB	MicroSD, up to 256GB
Network Interface	10M/100M Base-TX Ethernet	10M/100M Base-TX Ethernet
Reset Button	N/A	N/A
Power	DC 12V ±25% PoE (IEEE 802.3af)	DC 12V ±25% PoE (IEEE 802.3af)
Working Environment	-30°C ~ 60°C (-22°F ~ 140°F)	-30°C ~ 60°C (-22°F ~ 140°F)
Ingress Protection	IP67	IP67
Vandal Resistant	IK10	N/A
Weight	0.92kg (2.0lb)	0.44kg (0.97lb)
Power Consumption	Max 9.0W	Max 7.5W
Dimensions(L × W × H)	246 × 86 × 85mm (9.7" × 3.4" × 3.3")	Φ 110.5 × 94.1mm (Φ 4.4" × 3.7")

Prime IV

Model	IPC2A22SA-DZK	IPC3232SA-DZK	IPC3632SA-ADZK	IPC2224SA-DF40(60)K	IPC3534SA-DF28(40)K
Appearance					
Axis	3-Axis	3-Axis	3-Axis	3-Axis	3-Axis
Low illumination characteristics	Lighthunter	Lighthunter	Lighthunter	Lighthunter	Lighthunter
Adjustment angle	Pan: 0°~360° Tilt: 0°~80° Rotate: 0°~360°	Pan: 0°~355° Tilt: 0°~68° Rotate: 0°~355°	Pan: 0°~360° Tilt: 0°~75° Rotate: 0°~360°	Pan: 0°~360° Tilt: 0°~90° Rotate: 0°~360°	Pan: 0°~355° Tilt: 0°~70° Rotate: 0°~355°
Sensor	1/2.7"/2MP/CMOS	1/2.7"/2MP/CMOS	1/2.7"/2MP/CMOS	1/1.8"/4MP/CMOS	1/1.8"/4MP/CMOS
Wide Dynamic Range	120dB True WDR	120dB True WDR	120dB True WDR	120dB True WDR	120dB True WDR
Zoom	Motorized	Motorized	Motorized	Fixed	Fixed
Lens	Focus: 2.7~13.5mm Iris: F1.35 Angle of view(H): 114° ~ 31.8°	Focus: 2.7~13.5mm Iris: F1.35 Angle of view(H): 114° ~ 31.8°	Focus: 2.7~13.5mm Iris: F1.35 Angle of view(H): 114° ~ 31.8°	Focus: 4mm, 6mm Iris: F1.6 Angle of view(H): 94.7°/68.1°	Focus: 2.8mm, 4mm Iris: F1.6 Angle of view(H): 103.8°/94.7°
Iris	Fixed	Fixed	Fixed	Fixed	Fixed
Min. illumination	Color: 0.001Lux (F1.35, AGC ON) 0 Lux with IR	Color: 0.001Lux (F1.35, AGC ON) 0 Lux with IR	Color: 0.001Lux (F1.35, AGC ON) 0 Lux with IR	Color: 0.0005Lux (F1.2, AGC ON) 0 Lux with IR	Color: 0.001Lux (F1.6, AGC ON) 0 Lux with IR
IR	Up to 50m (164ft)	Up to 40m (131 ft)	Up to 40m (131 ft)	Up to 50m (164 ft)	Up to 50m (164 ft)
Video Compression	Ultra265, H.265, H.264, MJPEG	Ultra265, H.265, H.264, MJPEG	Ultra265, H.265, H.264, MJPEG	Ultra265, H.265, H.264, MJPEG	Ultra265, H.265, H.264, MJPEG
Smart Function	√	√	√	√	√
Frame Rate	1920×1080 30fps	1920×1080 30fps	1920×1080 30fps	2688×1520 30fps 2560×1440 30fps 1920×1080 30fps	2688×1520 30fps 2560×1440 30fps 1920×1080 60fps
ROI (Region of Interest)	√	√	√	√	√
9:16 Corridor Mode	√	√	√	√	√
Video Streaming	Triple streams	Triple streams	Triple streams	Triple streams	Triple streams
Privacy Mask	√	√	√	√	√
OSD font	vector	vector	vector	vector	vector
The number of OSD	Up to 8 OSDs	Up to 8 OSDs	Up to 8 OSDs	Up to 8 OSDs	Up to 8 OSDs
Audio I/O	1 / 1	1 / 1	1 / 1, Built-in Mic	1 / 1	1 / 1
Alarm I/O	1 / 1	1 / 1	1 / 1	1 / 1	1 / 1
BNC	N/A	N/A	N/A	N/A	N/A
Edge Storage	MicroSD, up to 256GB	MicroSD, up to 256GB	MicroSD, up to 256GB	MicroSD, up to 256GB	MicroSD, up to 256GB
Network Interface	10M/100M Base-TX Ethernet	10M/100M Base-TX Ethernet	10M/100M Base-TX Ethernet	10M/100M Base-TX Ethernet	10M/100M Base-TX Ethernet
Reset Button	√	√	√	√	√
Power	DC12V±25% PoE (IEEE 802.3af)	DC12V±25% PoE (IEEE 802.3af)	DC12V±25% PoE (IEEE 802.3af)	DC12V±25% PoE (IEEE 802.3af)	DC12V±25% PoE (IEEE 802.3af)
Working Environment	-30°C~60°C(-22°F ~ 140°F)	-30°C~60°C(-22°F ~ 140°F)	-30°C~60°C(-22°F ~ 140°F)	-40°C~60°C(40°F ~ 140°F)	-40°C~60°C(-40°F ~ 140°F)
Ingress Protection	IP67	IP67	IP67	IP67	IP67
Vandal Resistant	IK10	IK10	IK10	IK10	IK10
Weight	1.14kg (2.51lb)	0.96kg(2.12lb)	0.70kg (1.54lb)	0.90kg(1.98lb)	0.59kg(1.3lb)
Power Consumption	Max 8.5W	Max 7.2W	Max 7.8W	Max 8.5W	Max 8.3W
Dimensions(L × W × H)	274.4×98.1×89.7mm (10.8"×3.9"×3.5")	Φ 148x111.3mm (Φ 5.8"×4.4")	Φ 129.1 × 111.2mm (Φ 5.1" × 4.4")	Φ 245.6x85.7x85.4mm(Φ 12.1"×3.4"×3.4")	Φ 128.1 × 99.9mm(Φ 5.04" × 3.93")

Prime IV

Model	IPC3234SA-DZK	IPC264SA-DZK	IPC2A25SA-DZK	IPC3235SA-DZK
Appearance				
Axis	3-Axis	3-Axis	3-Axis	3-Axis
Low illumination characteristics	Lighthunter	Lighthunter	Lighthunter	Lighthunter
Adjustment angle	Pan: 0°~355° Tilt: 0°~68° Rotate: 0°~355°	Pan: 0°~360° Tilt: 0°~90° Rotate: 0°~360°	Pan: 0°~360° Tilt: 0°~90° Rotate: 0°~360°	Pan: 0°~355° Tilt: 0°~80° Rotate: 0°~355°
Sensor	1/1.8"/4MP/CMOS	1/1.8"/4MP/CMOS	1/2.7"/5MP/CMOS	1/2.7"/5MP/CMOS
Wide Dynamic Range	120dB True WDR	120dB True WDR	120dB True WDR	120dB True WDR
Zoom	Motorized	Motorized	Motorized	Motorized
Lens	Focus: 2.8~12mm Iris: F1.2 Angle of view(H): 107.9°~35.6°	Focus: 2.8~12mm Iris: F1.2 Angle of view(H): 107.9°~35.6°	Focus: 2.7~13.5mm Iris: F1.2 Angle of view(H): 93.1°~26.8°	Focus: 2.7~13.5mm Iris: F1.2 Angle of view(H): 93.1°~26.8°
Iris	Auto aperture	Auto aperture	Auto aperture	Auto aperture
Min. illumination	Color: 0.0005Lux (F1.2, AGC ON) 0 Lux with IR	Color: 0.0005Lux (F1.2, AGC ON) 0 Lux with IR	Color: 0.002Lux (F1.2, AGC ON) 0 Lux with IR	Color: 0.002Lux (F1.2, AGC ON) 0 Lux with IR
IR	Up to 40m (131 ft)	Up to 50m (164ft)	Up to 50m (164ft)	Up to 50m (164ft)
Video Compression	Ultra265, H.265, H.264, MJPEG	Ultra265, H.265, H.264, MJPEG	Ultra265, H.265, H.264, MJPEG	Ultra265, H.265, H.264, MJPEG
Smart Function	√	√	√	√
Frame Rate	2688×1520 30fps 1920×1080 60fps	2688×1520 30fps 1920×1080 60fps	2592×1944 20fps 2560×1440 30fps 2304×1296 30fps	2592×1944 20fps 2560×1440 30fps 2304×1296 30fps 1920×1080 30fps
ROI (Region of Interest)	√	√	√	√
9:16 Corridor Mode	√	√	√	√
Video Streaming	Triple streams	Triple streams	Triple streams	Triple streams
Privacy Mask	√	√	√	√
OSD font	vector	vector	vector	vector
The number of OSD	Up to 8 OSDs	Up to 8 OSDs	Up to 8 OSDs	Up to 8 OSDs
Audio I/O	1 / 1	1 / 1	1 / 1	1 / 1
Alarm I/O	1 / 1	2 / 1	1 / 1	1 / 1
BNC	N/A	N/A	N/A	N/A
Edge Storage	MicroSD, up to 256GB	MicroSD, up to 256GB	MicroSD, up to 256GB	MicroSD, up to 256GB
Network Interface	10M/100M Base-TX Ethernet	10M/100M Base-TX Ethernet	10M/100M Base-TX Ethernet	10M/100M Base-TX Ethernet
Reset Button	√	√	√	√
Power	AC24V±25%, DC12V±25% PoE (IEEE802.3af)	AC24V±25%, DC 12V (-10%,+25%) PoE (IEEE802.3at)	DC12V±25% PoE (IEEE802.3af)	DC12V±25% PoE (IEEE802.3af)
Working Environment	-30°C~60°C(-22°F ~ 140°F)	-30°C~60°C(-22°F ~ 140°F)	40°C~60°C(-22°F ~ 140°F)	-30°C~60°C(-22°F ~ 140°F)
Ingress Protection	IP67	IP67	IP67	IP67
Vandal Resistant	IK10	IK10	IK10	IK10
Weight	0.96kg(2.12lb)	1.65kg(3.64lb)	1.12kg(2.46lb)	0.93kg(2.05lb)
Power Consumption	Max 10W	Max 14W	Max 10W	Max 10.8W
Dimensions(L × W × H)	Φ 148x111.3mm (Φ 5.8"×4.4")	Φ 306.4x104.1x98.4mm(Φ 12.1"×4.1"×3.9")	Φ 274.4x98.1x89.6mm(Φ 10.8"×3.9"×3.5")	Φ 148.0 × 111.4mm (Φ 5.8" × 4.4")



Network Camera

UNV Pro series are born with excellent ultra-smart technology, deliver superior users experience.

Applied with smart function, products in Pro series are able to suit for a range of tough situations. 4K@30fps, 2MP@60fps, LightHunter, WDR, abundant interfaces, in addition to those performance, Pro series also include OmniView camera, which combines multiple sensors to provide a panoramic view.

Besides, AlphaView is a series of cameras that built-in high-end intelligent chip and deep learning algorithm. It focuses on people and vehicles in an image with high accuracy, enabling users to focus on real events.

The Pro series products are the first option for enterprise and project applications.



IPC8542ER5-DUP

- LightHunter, minimum 0.002 Lux illumination
- Smart IR and optical glass window, supports up to 50m IR distance
- 180° Horizontal viewing angle
- Ultra-smart functions



IPC268EA-DZK

- 8MP@30fps
- LightHunter, minimum 0.002 Lux illumination
- 1/1.8" progressive scan CMOS
- F1.2 big iris lens
- IR: Up to 100M
- 120dB true WDR
- Audio 1/1, Alarm 2/1
- IP67, IK10
- Deep learning



IPC3234EA-HDZK

- 4MP@60fps
- LightHunter, minimum 0.0005 Lux illumination
- 1/1.8" progressive scan CMOS
- F1.2 big iris lens
- IR: Up to 40M
- 120dB true WDR
- Audio 1/1, Alarm 1/1
- IP67, IK10
- Deep learning

LightHunter

Most of products in Pro series are powered by LightHunter, which perform excellent in low illumination environment. LightHunter technology is popularly applied in projects like airport, highway, or safe city applications.

4K

4K series delivers box camera, 4x bullet/dome camera at 30fps. The higher the resolution is, the wider surveillance range reaches and it would be easy to zoom in by digital zoom to get more details. As we all know, 4K 30fps generates higher bitrate and bandwidth and also results in higher storage cost. To solve this problem, UNV Ultra 265 deep video compression technology can perfectly solve the problem by reducing up to 90% bitrate without losing any details.

High Reliability

Wide voltage range of $\pm 25\%$
Wide temperature range: $-40^{\circ}\text{C} \sim 60^{\circ}\text{C}$
Surge protection designed for network interface



AlphaView

AlphaView is a series of cameras with built-in high-end intelligent chip and deep learning algorithm. It focuses on people and vehicles with high precision, enabling users to focus on real events. Based on Uniview's advanced technology, AlphaView makes video intelligent, reliable and efficient.



Powered by intelligent chip and deep learning algorithms, Alphaview provides excellent and complete human & vehicle-oriented technologies including people counting, face recognition, video metadata, and smart intrusion prevention. Compared with the previous intelligent functions, these functions greatly improve accuracy. Administrators can act quickly and accurately on important matters.

AlphaView products are 4MP@60fps or 8MP@30fps equipped with LightHunter technology. LightHunter Technology is an innovative technology that delivers vivid color, appropriate brightness, and extremely clear images in ultra-low light. Additionally, 1/1.8" high light sensitivity sensors and F1.2 big iris are perfectly integrated to demon-

PRO Basic

Model	IPC868ER-VF18-B	IPC8542ER5-DUG	IPC8542ER5-DUP
Appearance			
Axis	3-Axis	N/A	N/A
Low illumination characteristics	Low-light	LightHunter(0.002lux)	LightHunter(0.002lux)
Adjustment angle	N/A	N/A	N/A
Sensor	1/1.8"/12MP/CMOS	1/1.8"/4*2MP/CMOS	1/1.8"/4*2MP/CMOS
Wide Dynamic Range	Digital WDR	120dB True WDR	120dB True WDR
Zoom	Fixed	Fixed	Fixed
Lens	Focus:1.8mm Iris: F2.4 Angle of View: 360°	Focus:4.2mm Iris: F1.8 Angle of view (H): 180° Angle of view (V): 80°	Focus:4.2mm Iris: F1.8 Angle of view (H): 180° Angle of view (V): 80°
Iris	Fixed	Fixed	Fixed
Min. illumination	Color: 0.05Lux (F2.4, AGC ON) 0Lux with IR	Color: 0.002Lux (F1.8, AGC ON) 0Lux with IR	Color: 0.002Lux (F1.8, AGC ON) 0Lux with IR
IR	Up to 10 m (33ft)	Up to 50m (164ft)	Up to 30m (98.4ft)
Video Compression	Ultra 265, H.265, H.264, MJPEG	Ultra 265, H.265, H.264, MJPEG	Ultra265, H.265, H.264, MJPEG
Smart Function	√	√	√
Frame Rate	4096*3000 15fps 3000*3000 15fps 2560*2560 25fps	4096*1800 30fps 2880*1264 30fps	4096*1800 30fps 2880*1264 30fps
ROI(Region of Interest)	√	√	√
9:16 Corridor Mode	√	√ (9:20)	√ (9:20)
Video Streaming	8 Streams (1 fisheye view (Triple streams), 1 panoramic view, 4 PTZ View)	Triple streams	Triple streams
Privacy Mask	√	√	√
OSD font	vector	vector	vector
The number of OSD	Up to 8 OSDs	Up to 8 OSDs	Up to 8 OSDs
Audio I/O	1 / 1 and 1 built-in Mic, 1 built-in Speaker	1 / 1	1 / 1
Alarm I/O	2 / 1	2 / 1	2 / 1
BNC	1	×	×
Edge Storage	MicroSD, up to 256GB	MicroSD, up to 256GB	MicroSD, up to 256GB
Network Interface	10M/100M Base-TX Ethernet	1*100M/1000M SFP + 2*10M/100M/1000M Base-TX Ethernet	2*10M/100M/1000M Base-TX Ethernet
Reset Button	√	√	√
Power	DC 12V ±25% PoE (IEEE 802.3af)	AC 24V ±25%, DC24V Support 18V-48V PoE (IEEE 802.3at)	AC 24V ±25%, DC24V Support 18V-48V PoE (IEEE 802.3at)
Working Environment	-35°C ~ 60°C (-31°F ~ 140°F)	-40°C ~ 70°C (-40°F ~ 158°F)	-40°C ~ 70°C (-40°F ~ 158°F)
Ingress Protection	IP66	IP67	IP67
Vandal Resistant	IK10	N/A	N/A
Weight	0.5kg (1.1lb)	2.4kg(5.3lb)	2.38kg(5.25lb)
Power Consumption	Max 11.7W	Max 45W	Max 23.6W
Dimensions(L × W × H)	Φ149×51.5mm (Φ5.9"×2.0")	259mm×211mm×115mm (10.2"×8.3"×4.5")	259mm×211mm×115mm (10.2"×8.3"×4.5")

PRO AlphaView

Model	IPC264EA-HDZK	IPC3234EA-HDZK	IPC268EA-DZK	IPC3238EA-DZK
Appearance				
Axis	3-Axis	3-Axis	3-Axis	3-Axis
Low illumination characteristics	Lighthunter	Lighthunter	Lighthunter	Lighthunter
Adjustment angle	Pan: 0°~360° Tilt: 0°~90° Rotate: 0°~360°	Pan: 0°~355° Tilt: 0°~70° Rotate: 0°~355°	Pan: 0°~360° Tilt: 0°~90° Rotate: 0°~360°	Pan: 0°~355° Tilt: 0°~70° Rotate: 0°~355°
Sensor	1/1.8"/4MP/CMOS	1/1.8"/4MP/CMOS	1/1.8"/8MP/CMOS	1/1.8"/8MP/CMOS
Wide Dynamic Range	120dB True WDR	120dB True WDR	120dB True WDR	120dB True WDR
Zoom	Motorized	Motorized	Motorized	Motorized
Lens	Focus: 2.8~12mm Iris: F1.2 Angle of view: 113.7°~42.6°	Focus: 2.8~12mm Iris: F1.2 Angle of view: 113.7°~42.6°	Focus: 2.8~12mm Iris: F1.2 Angle of view: 106.5°~41.6°	Focus: 2.8~12mm Iris: F1.2 Angle of view: 106.5°~41.6°
Iris	Auto aperture	Auto aperture	Auto aperture	Auto aperture
Min. illumination	Color: 0.0005Lux (F1.2, AGC ON) 0 Lux with IR	Color: 0.0005Lux (F1.2, AGC ON) 0 Lux with IR	Color: 0.002Lux (F1.2, AGC ON) 0 Lux with IR	Color: 0.002Lux (F1.2, AGC ON) 0 Lux with IR
IR	Up to 100m (328ft)	Up to 40m (131 ft)	Up to 100m (328ft)	Up to 40m (131 ft)
Video Compression	Ultra265, H.265, H.264, MJPEG	Ultra265, H.265, H.264, MJPEG	Ultra265, H.265, H.264, MJPEG	Ultra265, H.265, H.264, MJPEG
Smart Function	√	√	√	√
Frame Rate	2688×1520 60fps	2688×1520 60fps	3840×2160 30fps	3840×2160 30fps
ROI(Region of Interest)	√	√	√	√
9:16 Corridor Mode	√	√	√	√
Video Streaming	Triple streams	Triple streams	Triple streams	Triple streams
Privacy Mask	√	√	√	√
OSD font	vector	vector	vector	vector
The number of OSD	Up to 8 OSDs	Up to 8 OSDs	Up to 8 OSDs	Up to 8 OSDs
Audio I/O	1 / 1	1 / 1	1 / 1	1 / 1
Alarm I/O	2 / 1	1 / 1	2 / 1	1 / 1
BNC	N/A	N/A	N/A	N/A
Edge Storage	MicroSD, up to 256GB	MicroSD, up to 256GB	MicroSD, up to 256GB	MicroSD, up to 256GB
Network Interface	10M/100M/1000M Base-TX Ethernet	10M/100M/1000M Base-TX Ethernet	10M/100M/1000M Base-TX Ethernet	10M/100M/1000M Base-TX Ethernet
Reset Button	√	√	√	√
Power	AC24V±25%, DC 12V (-10%,+25%) PoE (IEEE802.3at)	AC24V±25%, DC12V±25% PoE (IEEE802.3af)	AC24V±25%, DC 12V (-10%,+25%) PoE (IEEE802.3at)	AC24V±25%, DC12V±25% PoE (IEEE802.3af)
Working Environment	-40°C~60°C(-40°F ~ 140°F)	-40°C~60°C(-40°F ~ 140°F)	-40°C~60°C(-40°F ~ 140°F)	-40°C~60°C(-40°F ~ 140°F)
Ingress Protection	IP67	IP67	IP67	IP67
Vandal Resistant	IK10	IK10	IK10	IK10
Weight	1.60kg(3.52lb)	1kg(2.2lb)	1.60kg(3.52lb)	1kg(2.2lb)
Power Consumption	Max 13W	Max 8W	Max 14W	Max 10.3W
Dimensions(L × W × H)	Φ 306.4x104.1x98.4mm(Φ 12.1"×4.1"×3.9")	Φ 148x111.3mm (Φ 5.8"×4.4")	Φ 306.4x104.1x98.4mm(Φ 12.1"×4.1"×3.9")	Φ 148x111.3mm (Φ 5.8"×4.4")



Network Camera

UNV PTZ series cameras cover entry level, standard level and enhanced level, meet different customers' requirements.

Mini PTZ camera which targets to entry level market is featured with built in microphone, speaker and wifi, suitable for retail market. The standard and enhanced PTZ camera are suitable for vertical industry projects with up to 55x optical zoom, 4K, 60fps, LightHunter, long range IR distance, WDR, abundant interface and IK10. Specialized camera such as TeleView can be adopt in forest, harbor and city monitoring project. Besides, AlphaView PTZ cameras based on deep learning algorithm can realize target classification and attributes extraction, support advanced smart functions including face capture, perimeter protection, people counting, auto-tracking and video metadata.



IPC675LFW-AX4DUPKC-VG

- 4X optical zoom, 2.8~12mm motorized lens
- LightHunter, minimum 0.003 Lux illumination
- Active deterrence, effectively expel intruders
- Smart intrusion prevention, enjoy false alarm reduction
- White light, provide clear details
- 2-way Talk, built-in Mic & Speaker
- Support POE



IPC6858SR-X38UP-VC

- 38X Optical Zoom
- 1/1.8" sensor, LightHunter, minimum 0.002 Lux illumination
- Smart IR, up to 250m (820ft) IR distance
- Gyroscope stabilization
- Support PoE (IEEE 802.3bt)
- Optical Defog
- AlphaView, support deep-learning algorithm



IPC7642ER-X55U-VC

- 55X Optical zoom
- LightHunter, minimum 0.003 Lux illumination
- Up to 400m IR distance
- Gyroscope stabilization
- Support deep-learning algorithm
- Rain-sensing auto wiper
- 7/2 alarm in/out
- Optical defog
- Embedded gradienter for installation

Excellent Image Performance

Powered by LightHunter, the PTZ series camera can perform well in low illumination environment. Besides, built in car-grade LED, PTZ series cameras support up to 250m IR.

AlphaView

Built in powerful chipset, the AlphaView series PTZ cameras adopt deep learning algorithm to realize smart functions. These PTZ cameras support face capture (extract face attributes), perimeter protection (target classification, only human or vehicle trigger alarm, filter most of false alarm), auto-tracking (target classification, track human or vehicle), people counting, video metadata (vehicle, human, non-motor vehicle snapshot and attributes extraction).

PTZ

Model	IPC6412LR-X5P	IPC6415SR-X5UPW	IPC6412SR-X5UPW-VG	IPC6415SR-X5UPW-VG	IPC672LR-ADUPKF40	IPC672LR-AX4DUPK
Appearance						
Low illumination characteristics	Low-light	LightHunter	LightHunter	LightHunter	Lighthunter	Lighthunter
Adjustment angle	N/A	N/A	N/A	N/A	N/A	N/A
Sensor	1/2.9"/2MP/CMOS	1/2.7"/5MP/CMOS	1/2.7"/5MP/CMOS	1/2.7"/5MP/CMOS	1/2.8"/2MP/CMOS	1/2.8"/2MP/CMOS
Lens	Focus: 2.7~13.5mm Iris: F1.2 Angle of view (H): 104.3°~29.1°	Focus: 2.7~13.5mm Iris: F1.2 Angle of view (H): 98.3°~27.9°	Focus: 2.7~13.5mm Iris: F1.2 Angle of view (H): 106.9°~30.6°	Focus: 2.7~13.5mm Iris: F1.2 Angle of view (H): 106.9°~30.6°	Focus: 4mm Iris: F1.6 Angle of view (H): 84.3°	Focus: 2.8~12m Iris: F1.6 Angle of view (H): 32.5°~95.7°
Optical Zoom	5X	5X	5X	5X	/	4X
WDR	Digital WDR	120dB	120dB	120dB	120dB True WDR	120dB True WDR
Iris	Auto aperture	Auto aperture	Auto aperture	Auto aperture	Fixed	Fixed
Min. illumination	Colour: 0.005 lux (F1.2, AGC ON) 0 lux with IR	Colour: 0.002 lux (F1.2, AGC ON) 0 lux with IR	Colour: 0.003 lux (F1.2, AGC ON) 0 lux with IR	Colour: 0.003 lux (F1.2, AGC ON) 0 lux with IR	Color: 0.001lux (F1.6, AGC ON), 0 lux with IR	Color: 0.001lux (F1.6, AGC ON), 0 lux with IR
Pan Range	350°	350°	350°	350°	345°	345°
Pan Speed	0.1°/s ~ 60°/s	0.1°/s ~ 60°/s	0.1°/s ~ 60°/s	0.1°/s ~ 60°/s	0.1°/s ~ 50°/s	0.1°/s ~ 50°/s
Tilt Range	0° ~ 90°	0° ~ 90°	0° ~ 90°	0° ~ 90°	90°	90°
Tilt Speed	0.1° ~ 50°/s	0.1° ~ 50°/s	0.1° ~ 50°/s	0.1° ~ 50°/s	0.1° ~ 40°/s	0.1° ~ 40°/s
Auto Tracking	/	/	/	/	√	√
ROI (Region of Interest)	√	√	√	√	√	√
IR	UP to 30m (98ft)	UP to 30m (98ft)	UP to 30m (98ft)	UP to 30m (98ft)	UP to 30m (98ft)	UP to 50m (164ft)
Video Compression	Ultra 265, H.265, H.264, MJPEG	Ultra 265, H.265, H.264, MJPEG	Ultra 265, H.265, H.264, MJPEG	Ultra 265, H.265, H.264, MJPEG	Ultra 265, H.265, H.264, MJPEG	Ultra 265, H.265, H.264, MJPEG
Smart Function	N/A	√	√	√	√	√
OSD font	vector	vector	vector	vector	vector	vector
The number of OSD	Up to 4 OSDs	Up to 8 OSDs	Up to 8 OSDs	Up to 8 OSDs	Up to 8 OSDs	Up to 8 OSDs
Frame Rate	1920×1080 30fps	2592 × 1944 30fps	1920 × 1080 30fps	2880 × 1620 30fps	1920 × 1080 30fps	1920 × 1080 30fps
Video Streaming	Triple streams	Triple streams	Triple streams	Triple streams	Triple streams	Triple streams
BNC	N/A	N/A	N/A	N/A	N/A	N/A
Privacy Mask	√	√	√	√	√	√
Patrol	N/A	N/A	N/A	N/A	√	√
Preset	1024	1024	1024	1024	256	256
Audio I/O	Built-in Mic	Built-in Mic Built-in Speaker	Built-in Mic Built-in Speaker	Built-in Mic Built-in Speaker	/	/
Alarm I/O	N/A	1 / 1	1 / 1	1 / 1	/	/
Edge Storage	MicroSD, up to 256GB	MicroSD, up to 256GB	MicroSD, up to 256GB	MicroSD, up to 256GB	MicroSD, up to 128GB	MicroSD, up to 128GB
Network Interface	10M/100M Base-TX Ethernet	10M/100M Base-TX Ethernet	10M/100M Base-TX Ethernet	10M/100M Base-TX Ethernet	10M/100M Base-TX Ethernet	10M/100M Base-TX Ethernet
Reset Button	√	√	√	√	√	√
Power	DC 12V±25% PoE (IEEE 802.3af)	DC 12V±25% PoE (IEEE802.3 at)	DC 12V±25% PoE (IEEE802.3 at)	DC 12V±25% PoE (IEEE802.3 at)	DC 12V±25% PoE (IEEE 802.3af)	DC 12V±25% PoE (IEEE 802.3af)
Ingress Protection	N/A	N/A	N/A	N/A	IP66	IP66
Working Environment	-10°C ~ +50°C (14°F ~ 122°F)	-10°C ~ +50°C (14°F ~ 122°F)	-10°C ~ +50°C (14°F ~ 122°F)	-10°C ~ +50°C (14°F ~ 122°F)	-20°C ~ 60°C (-4°F ~ 140°F)	-20°C ~ 60°C (-4°F ~ 140°F)
Weight	0.75kg(1.65lb)	0.75kg(1.65lb)	0.75kg(1.65lb)	0.75kg(1.65lb)	0.8Kg(1.76lb)	0.87Kg(1.92lb)
Power Consumption	12W	16W	Max 13W	Max 13W	Max 14W	Max 16W
Dimensions	Φ 129mm×143mm(Φ 5.07" x 5.63")	Φ 129mm×143mm(Φ 5.07" x 5.63")	Φ 129 x 143.6mm (Φ 5.1" x 5.7")	Φ 129 x 143.6mm (Φ 5.1" x 5.7")	Φ 133 x 248.4mm (Φ 5.2" x 9.8")	Φ 133 x 248.4mm (Φ 5.2" x 9.8")

PTZ

Model	IPC672LR-AX4DUPKC	IPC675LFW-AX4DUPKC-VG	IPC6322LR-X33U-D	IPC6322SR-X33UP-D	IPC6322LR-X22-D
Appearance					
Low illumination characteristics	Lighthunter	Lighthunter	LightHunter	LightHunter	Lighthunter
Adjustment angle	N/A	N/A	N/A	N/A	N/A
Sensor	1/2.8"/2MP/CMOS	1/2.7"/5MP/CMOS	1/2.8"/2MP/CMOS	1/2.8"/2MP/CMOS	1/2.8"/2MP/CMOS
Lens	Focus: 2.8~12m Iris: F1.6 Angle of view (H): 32.5° ~ 95.7°	Focus: 2.8~12m Iris: F1.6 Angle of view (H): 32.5° ~ 95.7°	Focus: 4.5~ 148.5mm Iris: F1.5~F4.0 Angle of view (H): 56.2°~2.6°	Focus: 4.5~ 148.5mm Iris: F1.5~F4.0 Angle of view (H): 56.2°~2.6°	Focus: 5.2~114.4mm Iris: F1.5~F3.8 Angle of view (H): 53.4° ~ 2.7°
Optical Zoom	4X	4X	33x	33x	22X
WDR	120dB True WDR	120dB True WDR	120dB True WDR	120dB True WDR	120dB True WDR
Iris	Fixed	Fixed	DC-Iris	DC-Iris	DC-Iris
Min. illumination	Color: 0.001lux (F1.6, AGC ON), 0 lux with IR	Color: 0.003lux (F1.6, AGC ON), 0 lux with IR	Color: 0.001Lux (F1.5, AGC ON) 0Lux with IR	Color: 0.001Lux (F1.5, AGC ON) 0Lux with IR	Color: 0.001lux (F1.5, AGC ON), 0 lux with IR
Pan Range	345°	345°	360°	360°	360°
Pan Speed	0.1°/s ~ 50°/s	0.1°/s ~ 50°/s	0.1°/s ~ 240°/s	0.1°/s ~ 240°/s	0.1°/s ~ 240°/s
Tilt Range	90°	-15° ~ +90°	-15° ~ +90°	-15° ~ +90°	-15° ~ +90°
Tilt Speed	0.1° ~ 40°/s	0.1° ~ 40°/s	0.1° ~ 80°/s	0.1° ~ 80°/s	0.1° ~ 80°/s
Auto Tracking	√	√	√	√	√
ROI (Region of Interest)	√	√	√	√	√
IR	UP to 50m (164ft)	UP to 50m (164ft)	Up to 150m (492ft)	Up to 150m (492ft)	UP to 150m (492ft)
Video Compression	Ultra265, H.265, H.264, MJPEG	Ultra265, H.265, H.264, MJPEG	Ultra 265, H.265, H.264, MJPEG	Ultra 265, H.264, MJPEG	Ultra265, H.265, H.264, MJPEG
Smart Function	√	√	√	√	√
OSD font	vector	vector	vector	vector	vector
The number of OSD	Up to 8 OSDs	Up to 8 OSDs	Up to 8 OSDs	Up to 8 OSDs	Up to 8 OSDs
Frame Rate	1920*1080 30fps	2880*1620 25fps	1920*1080 60fps	1920*1080 60fps	1920 × 1080 60fps
Video Streaming	Triple streams	Triple streams	Triple streams	Triple streams	Triple streams
BNC	N/A	N/A	√	√	N/A
Privacy Mask	√	√	√	√	√
Patrol	√	√	√	√	√
Preset	256	256	1024	1024	1024
Audio I/O	/	Built-in Mic, Built-in Speaker	1 / 1	1 / 1	N/A
Alarm I/O	/	/	2 / 1	2 / 1	N/A
Edge Storage	MicroSD, up to 128GB	MicroSD, up to 256GB	MicroSD, up to 256GB	MicroSD, up to 256GB	MicroSD, up to 256GB
Network Interface	10M/100M Base-TX Ethernet	10M/100M Base-TX Ethernet	10M/100M Base-TX Ethernet	10M/100M Base-TX Ethernet	10M/100M Base-TX Ethernet
Reset Button	√	√	√	√	√
Power	DC 12V ±25% PoE (IEEE 802.3af)	DC 12V ±25% PoE (IEEE 802.3af)	DC 12V±10%	DC 12V±10% PoE (PSE Required)	DC 12V±10%
Ingress Protection	IP66	IP66	IP66	IP66	IP66
Working Environment	-20°C ~ 60°C (-4°F ~ 140°F)	-20°C ~ 60°C (-4°F ~ 140°F)	-40°C ~ 65°C (-40°F ~ 149°F)	-40°C ~ 65°C (-40°F ~ 149°F)	-40°C ~ 65°C (-40°F ~ 149°F)
Weight	0.87Kg(1.92lb)	0.87Kg(1.92lb)	3.4kg (7.5lb)	3.4kg (7.5lb)	3.3kg (7.3lb)
Power Consumption	Max 16W	Max 18W	Max 22W	Max 22W	Max 23.5W
Dimensions	Φ 133 x 269.4mm (Φ 5.2" x 10.6")	Φ 133 x 274mm (Φ 5.2" x 10.8")	Φ 220×369mm (Φ 8.7" x 14.5")	Φ 220×369mm (Φ 8.7" x 14.5")	Φ 220 x 369mm (Φ 8.7" x 14.5")

PTZ

Model	IPC6322SR-X22P-D	IPC6222EI-X33UP	IPC6222E-X33UP	IPC6252SR-X22U	IPC6252SFW-X22U
Appearance					
Low illumination characteristics	Lighthunter	Lighthunter	Lighthunter	Lighthunter	Lighthunter
Adjustment angle	N/A	N/A	N/A	N/A	N/A
Sensor	1/2.8" / 2MP / CMOS	1/2.8" / 2MP / CMOS	1/2.8" / 2MP / CMOS	1/1.8" / 2MP / CMOS	1/1.8" / 2MP / CMOS
Lens	Focus: 5.2~114.4mm Iris: F1.5~F3.8 Angle of view (H): 53.4° ~ 2.7°	Focus: 4.5~148.5mm Iris: F1.5~F4.0 Angle of view (H): 62.67° ~ 2.82°	Focus: 4.5~148.5mm Iris: F1.5~F4.0 Angle of view (H): 62.67° ~ 2.82°	Focus: 6.5~143mm Iris: F1.5~F3.4 Angle of view (H): 57.24° ~ 3.29°	Focus: 6.5~143mm Iris: F1.5~F3.4 Angle of view (H): 57.24° ~ 3.29°
Optical Zoom	22X	33X	33X	22X	22X
WDR	120dB True WDR	120dB True WDR	120dB True WDR	120dB True WDR	120dB True WDR
Iris	DC-Iris	DC-Iris	DC-Iris	DC-Iris	DC-Iris
Min. illumination	Color: 0.001Lux (F1.5, AGC ON), 0Lux with IR	Colour: 0.001Lux (F1.5, AGC ON) B/W: 0.0001Lux (F1.5, AGC ON)	Color: 0.001Lux (F1.5, AGC ON) B/W: 0.0001Lux (F1.5, AGC ON)	Color: 0.0005Lux (F1.5, AGC ON) 0Lux with IR	Color: 0.0005Lux (F1.5, AGC ON) 0Lux with IR on
Pan Range	360°	360°	360°	360°	360°
Pan Speed	0.1°/s ~ 240°/s	0.1°/s ~ 400°/s	0.1°/s ~ 400°/s	0.1°/s ~ 240°/s	0.1°/s ~ 240°/s
Tilt Range	-15° ~ 90°	1° ~ 90°	1° ~ 90°	-15° ~ 90°	-15° ~ 90°
Tilt Speed	0.1° ~ 80°/s	0.1° ~ 240°/s	0.1° ~ 240°/s	0.1° ~ 160°/s	0.1° ~ 160°/s
Auto Tracking	√	√	√	√	√
ROI (Region of Interest)	√	√	√	√	√
IR	Up to 150m (492ft)	N/A	N/A	Up to 200m (656ft)	IR Light, up to 200m (656ft), White Light, up to 30m (98.4ft)
Video Compression	Ultra265, H.265, H.264, MJPEG	Ultra265, H.265, H.264, MJPEG	Ultra265, H.265, H.264, MJPEG	Ultra265, H.265, H.264, MJPEG	Ultra265, H.265, H.264, MJPEG
Smart Function	√	√	√	√	√
OSD font	vector	vector	vector	vector	vector
The number of OSD	Up to 8 OSDs	Up to 8 OSDs	Up to 8 OSDs	Up to 8 OSDs	Up to 8 OSDs
Frame Rate	1920 × 1080 60fps	1920 × 1080 60fps	1920 × 1080 30fps	1920 × 1080 60fps	1920 × 1080 60fps
Video Streaming	Triple streams	Triple streams	Triple streams	Triple streams	Triple streams
BNC	N/A	√	√	√	√
Privacy Mask	√	√	√	√	√
Patrol	√	√	√	√	√
Preset	1024	1024	1024	1024	1024
Audio I/O	1 / 1	1 / 1	1 / 1	1 / 1	1 / 1
Alarm I/O	1 / 1	2 / 1	2 / 1	2 / 1	2 / 1
Edge Storage	MicroSD, up to 256GB	MicroSD, up to 256GB	MicroSD, up to 256GB	MicroSD, up to 256GB	MicroSD, up to 256GB
Network Interface	10M/100M Base-TX Ethernet	10M/100M Base-TX Ethernet	10M/100M Base-TX Ethernet	10M/100M Base-TX Ethernet	10M/100M Base-TX Ethernet
Reset Button	√	N/A	√	√	√
Power	DC 12V±10%, PoE (PSE required)	AC 24V ±25%, DC 24V ±25% PoE (IEEE 802.3at)	AC 24V ±25%, DC 24V ±25% PoE (IEEE 802.3at)	AC 24V ±25%, DC 24V ±25%	AC 24V ±25%, DC 24V ±25%
Ingress Protection	IP66	IK10	IP67	IP66	IP66
Working Environment	-40°C ~ 65°C (-40°F ~ 149°F)	-20°C ~ 50°C (-4°F ~ 122°F)	-30°C ~ 70°C (-31°F ~ 158°F)	-40°C ~ 70°C (-40°F ~ 158°F)	-40°C ~ 70°C (-40°F ~ 158°F)
Weight	3.4kg (7.5lb)	2.9kg (6.4lb)	4.2kg (9.26lb)	5.5kg (12.1lb)	5.4kg (11.9lb)
Power Consumption	Max 27.6W	Max 15.5W	Max 16W	11 ~ 47W	12 ~ 46W
Dimensions	Φ 220 x 369mm (Φ 8.7" x 14.5")	Φ 195 x 263mm (Φ 7.7" x 10.4")	Φ 218 × 298mm (Φ 8.6" × 11.7")	Φ 227 × 359.4mm (Φ 8.9" × 14.2")	Φ 227 × 359.4mm (Φ 8.9" × 14.2")





PTZ

Model	IPC6252SR-X33U	IPC6252SL-X33UP	IPC6222ER-X20(P)-B	IPC6222ER-X30(P)-B	IPC6622SR-X33-VF
Appearance					
Low illumination characteristics	Lighthunter	Lighthunter, Laser	Lighthunter	Lighthunter	Lighthunter
Adjustment angle	N/A	N/A	N/A	N/A	N/A
Sensor	1/2.8" / 2MP / CMOS	1/2.8" / 2MP / CMOS	1/2.8" / 2MP / CMOS	1/2.8" / 2MP / CMOS	1/2.8" / 2MP / CMOS
Lens	Focus: 4.5~148.5mm Iris: F1.6~F5.3 Angle of view (H): 62.67° ~ 2.82°	Focus: 4.5~148.5mm Iris: F1.6~F5.3 Angle of view (H): 62.67° ~ 2.82°	Focus: 5.2~104mm Iris: F1.5~F4.0 Angle of view (H): 55.93° ~ 3.52°	Focus: 4.5~135mm Iris: F1.5~F4.0 Angle of view (H): 71.7° ~ 2.4°	Focus: 4.5~148.5mm Iris: F1.5~F4.0 Angle of view (H): 56.2 ~ 2.6°
Optical Zoom	33X	33X	20X	30X	33X
WDR	120dB True WDR	120dB True WDR	120dB True WDR	120dB True WDR	120dB True WDR
Iris	DC-Iris	DC-Iris	DC-Iris	DC-Iris	DC-Iris
Min. illumination	Color: 0.002Lux (F1.6, AGC ON) 0Lux with IR	Color: 0.002Lux (F1.6, AGC ON) 0Lux with IR	Color: 0.001Lux (F1.5, AGC ON) 0Lux with IR	Color: 0.001Lux (F1.5, AGC ON) 0Lux with IR	Colour: 0.001lux (F1.5, AGC ON), 0Lux with IR
Pan Range	360°	360°	360°	360°	360°
Pan Speed	0.1°/s ~ 240°/s	0.1°/s ~ 240°/s	0.1°/s ~ 240°/s	0.1°/s ~ 240°/s	0.1°/s ~ 240°/s
Tilt Range	-15° ~ 90°	-15° ~ 90°	-15° ~ 90°	-15° ~ 90°	-15° ~ +90°
Tilt Speed	0.1° ~ 160°/s	0.1° ~ 160°/s	0.1° ~ 160°/s	0.1° ~ 160°/s	0.1° ~ 160°/s
Auto Tracking	√	√	√	√	√
ROI (Region of Interest)	√	√	√	√	√
IR	Up to 200m (656ft)	VF laser, up to 500m (1640ft)	Up to 150m (492ft)	Up to 150m (492ft)	up to 150m (492ft)
Video Compression	Ultra265, H.265, H.264, MJPEG	Ultra265, H.265, H.264, MJPEG	Ultra265, H.265, H.264, MJPEG	Ultra265, H.265, H.264, MJPEG	Ultra265, H.265, H.264, MJPEG
Smart Function	√	√	√	√	√
OSD font	vector	vector	vector	vector	vector
The number of OSD	Up to 8 OSDs	Up to 8 OSDs	Up to 8 OSDs	Up to 8 OSDs	Up to 8 OSDs
Frame Rate	1920 × 1080 60fps	1920 × 1080 60fps	1920 × 1080 60fps	1920 × 1080 60fps	1920 × 1080 60fps
Video Streaming	Triple streams	Triple streams	Triple streams	Triple streams	Five streams
BNC	√	N/A	N/A	N/A	√
Privacy Mask	√	√	√	√	√
Patrol	√	√	√	√	√
Preset	1024	1024	1024	1024	1024
Audio I/O	1 / 1	1 / 1	1 / 1	1 / 1	1 / 1
Alarm I/O	2 / 1	1 / 1	1 / 1	1 / 1	2 / 1
Edge Storage	MicroSD, up to 256GB	MicroSD, up to 256GB	MicroSD, up to 256GB	MicroSD, up to 256GB	MicroSD, up to 256GB
Network Interface	10M/100M Base-TX Ethernet	10M/100M Base-TX Ethernet	10M/100M Base-TX Ethernet	10M/100M Base-TX Ethernet	10M/100M Base-TX Ethernet
Reset Button	√	√	N/A	N/A	√
Power	AC 24V ±25%, DC 24V ±25%	AC 24V ±25%, DC 24V ±25% PoE (PSE Required)	AC 24V ±25%, DC 24V ±25% PoE (-P, PSE Required)	AC 24V ±25%, DC 24V ±25% PoE (-P, PSE Required)	AC 24V ±25%, DC 24V ±25%, PoE (PSE Required)
Ingress Protection	IP66	IP66	IP66	IP66	IP66
Working Environment	-40°C ~ 70°C (-40°F ~ 158°F)	-40°C ~ 70°C (-40°F ~ 158°F)	-40°C ~ 65°C (-40°F ~ 149°F)	-40°C ~ 65°C (-40°F ~ 149°F)	-40°C ~ +65°C (-40°F ~ 149°F)
Weight	5.5kg (12.1lb)	5.6kg (12.3lb)	5.28kg (11.6lb)	5.28kg (11.6lb)	5.3kg (11.68lb)
Power Consumption	Max 49W	Max 49W	Max 60W	Max 60W	Max 48W
Dimensions	Φ 227 × 359.4mm (Φ 8.9" × 14.2")	Φ 227 × 359.4mm (Φ 8.9" × 14.2")	Φ 227 × 359.4mm (Φ 8.9" × 14.2")	Φ 227 × 359.4mm (Φ 8.9" × 14.2")	Φ 227 × 359.4mm (Φ 8.9" × 14.2")

PTZ

Model	IPC6254SR-X33DUP	IPC6258SR-X22DUP	IPC6852SR-X38UG	IPC6852SR-X44U	IPC6854SR-X38UP-VC
Appearance					
Low illumination characteristics	LightHunter	LightHunter	LightHunter	LightHunter	LightHunter
Adjustment angle	N/A	N/A	N/A	N/A	N/A
Sensor	1/2.8" / 4MP / CMOS	1/1.8" / 8MP / CMOS	1/1.8" / 2MP / CMOS	1/2.8" / 2MP / CMOS	1/1.8" / 4MP / CMOS
Lens	Focus: 4.5~148.5mm Iris: F1.5~F4.0 Angle of view (H): 52.4° ~ 2.2°	Focus: 6.5~ 143mm Iris: F1.5~F3.4 Angle of view (H): 58.9°~3.4°	Focus: 5.7~216.6mm Iris: F1.3~F4.5 Angle of view (H): 58.4°~2.08°	Focus: 5~220mm Iris: F1.2~F3.5 Angle of view (H): 60.62°~1.83°	Focus: 5.7~216.6mm Iris: F1.3~F4.6 Angle of view (H): 58.45°~2.14°
Optical Zoom	33X	22x	38X	44X	38X
WDR	120dB True WDR	120dB True WDR	120dB True WDR	120dB True WDR	120dB True WDR
Iris	DC-Iris	DC-Iris	DC-Iris	DC-Iris	DC-Iris
Min. illumination	Color: 0.003lux (F1.5, AGC ON), 0 lux with IR	Color: 0.003Lux (F1.5, AGC ON) 0Lux with IR	Color: 0.0005Lux (F1.5, AGC ON) 0Lux with IR	Color: 0.0005Lux (F1.2, AGC ON) 0Lux with IR	Color: 0.0005Lux (F1.3, AGC ON) 0Lux with IR
Pan Range	360°	360°	360°	360°	360°
Pan Speed	0.1°/s ~ 240°/s	0.1°/s ~ 74°/s	0.1°/s ~ 240°/s	0.1° ~ 74°/s	0.1° ~ 74°/s
Tilt Range	-15° ~ 90°	-15° ~ 90°	-20° ~ 90°	-15° ~ 90°	-20° ~ 90°
Tilt Speed	0.1° ~ 160°/s	0.1° ~ 74°/s	0.1° ~ 160°/s	0.1° ~ 160°/s	0.1° ~ 74°/s
Auto Tracking	√	√	√	√	√
ROI (Region of Interest)	√	√	√	√	√
IR	Up to 200m (656ft)	Up to 200m (656ft)	Up to 250m (820ft)	Up to 250m (820ft)	Up to 250m (820ft)
Video Compression	Ultra265, H.265, H.264, MJPEG	Ultra 265, H.265, H.264, MJPEG	Ultra265, H.265, H.264, MJPEG	Ultra265, H.265, H.264, MJPEG	Ultra265, H.265, H.264, MJPEG
Smart Function	√	√	√	√	√
OSD font	vector	vector	vector	vector	vector
The number of OSD	Up to 8 OSDs	Up to 8 OSDs	Up to 8 OSDs	Up to 8 OSDs	Up to 8 OSDs
Frame Rate	2688 x 1520 30fps	3840x2160 30fps	1920x1080 60fps	1920x1080 60fps	2688 x 1520 60fps
Video Streaming	Triple streams	Triple streams	Triple streams	Triple streams	Triple streams
BNC	N/A	N/A	√	√	N/A
Privacy Mask	√	√	√	√	√
Patrol	√	√	√	√	√
Preset	1024	1024	1024	1024	1024
Audio I/O	1 / 1	1 / 1	1 / 1	1 / 1	1 / 1
Alarm I/O	2 / 1	1 / 1	2 / 1	2 / 1	2 / 1
Edge Storage	MicroSD, up to 256GB	MicroSD, up to 256GB	MicroSD, up to 256GB	MicroSD, up to 256GB	MicroSD, up to 256GB
Network Interface	10M/100M Base-TX Ethernet	10M/100M Base-TX Ethernet	10M/100M/1000M Base-TX Ethernet 100M/1000M SFP	10M/100M Base-TX Ethernet	10M/100M Base-TX Ethernet
Reset Button	√	√	√	√	√
Power	AC 24V±25%, DC 24V±25%, PoE (PSE required)	AC 24V ±25%, DC 24V ±25% PoE (PSE Required)	AC 24V ±25%, DC 24V ±25%	AC 24V ±25%, DC 24V ±25%	AC 24V ±25%, DC 24V ±25% PoE++ (bt protocol)
Ingress Protection	IP66	IP66	IP66	IP66	IP66
Working Environment	-40°C ~ 65°C (-40°F ~ 149°F)	-40°C ~ 70°C (-40°F ~ 158°F)	-40°C ~ 70°C (-40°F ~ 158°F)	-40°C ~ 70°C (-40°F ~ 158°F)	-40°C ~ 70°C (-40°F ~ 158°F)
Weight	5.6kg(12.3lb)	5.55kg (12.24lb)	9.69kg (21.4lb)	9.69kg (21.4lb)	9.69kg (21.4lb)
Power Consumption	Max 54W	9 ~ 60W	16 ~ 51W	16 ~ 56W	16 ~ 51W
Dimensions	Φ 227 x 359.4mm (Φ 8.9" x 14.1")	Φ 227x359.4mm (Φ 8.9" x14.2")	Φ 270x496.7mm (Φ 10.6"x19.6")	Φ 270x496.7mm (Φ 10.6"x19.6")	Φ 270mmx496.7mm (Φ 10.6" x 19.6")

PTZ





Model	IPC6858SR-X38UP-VC	IPC6854SL-X40WUP-VC	IPC7622ER-X44U	IPC7642ER-X55U-VC
Appearance				
Low illumination characteristics	LightHunter	Lighthunter	Lighthunter	Lighthunter
Adjustment angle	N/A	N/A	N/A	N/A
Sensor	1/1.8" / 8MP / CMOS	1/1.8" / 4MP / CMOS	1/2.8" / 2MP / CMOS	1/1.8" / 4MP / CMOS
Lens	Focus: 5.7~216.6mm Iris: F1.5~F4.8 Angle of view (H): 61.2°~2.3°	Focus:5.7~228mm Iris: F1.3~F4.6 Angle of view (H): 58.5 ~ 2.1°	Focus: 5~220mm Iris: F1.2~F3.5 Angle of view (H): 60.6 ~ 1.83°	Focus: 6~330mm Iris: F1.6~F4.8 Angle of view (H): 61.5 ~ 1.9°
Optical Zoom	38X	40X	44X	55X
WDR	120dB True WDR	120dB True WDR	120dB True WDR	120dB True WDR
Iris	DC-Iris	P-Iris	DC-Iris	DC-Iris
Min. illumination	Color: 0.003Lux (F1.5, AGC ON) 0Lux with IR	0.0005lux (F1.3, AGC ON, Colour), 0 lux with IR	Color: 0.0005lux (F1.2, AGC ON), 0 lux with IR	0.003lux (F1.6, AGC ON, Colour), 0 lux with IR
Pan Range	360°	360°	360°	360°
Pan Speed	0.1° ~ 74°/s	0.1°/s ~ 300°/s	0.1°/s ~ 140°/s	0.1°/s ~ 140°/s
Tilt Range	-20° ~ 90°	-15° ~ +90°	-90° ~ +45°	-90° ~ +45°
Tilt Speed	0.1° ~ 74°/s	0.1° ~ 240°/s	0.1° ~ 50°/s	0.1° ~ 50°/s
Auto Tracking	√	√	√	√
ROI (Region of Interest)	√	√	√	√
IR	Up to 250m (820ft)	VF laser, up to 650m (2132ft)	Up to 300m (984ft)	Up to 400m (1312ft)
Video Compression	Ultra265, H.265, H.264, MJPEG	Ultra265, H.265, H.264, MJPEG	Ultra265, H.265, H.264, MJPEG	Ultra265, H.265, H.264, MJPEG
Smart Function	√	√	√	√
OSD font	vector	vector	vector	vector
The number of OSD	Up to 8 OSDs	Up to 8 OSDs	Up to 8 OSDs	Up to 8 OSDs
Frame Rate	3840 x 2160 30fps	2688x1520 60fps	1920 x 1080 60fps	2688x1520 30fps
Video Streaming	Triple streams	Penta streams	Triple streams	Penta streams
BNC	N/A	N/A	√	N/A
Privacy Mask	√	√	√	√
Patrol	√	√	√	√
Preset	1024	1024	1024	1024
Audio I/O	1 / 1	1 / 1	1 / 1	1 / 1
Alarm I/O	2 / 1	7 / 2	7 / 2	7 / 2
Edge Storage	MicroSD, up to 256GB	MicroSD, up to 256GB	MicroSD, up to 256GB	MicroSD, up to 256GB
Network Interface	10M/100M Base-TX Ethernet	10M/100M Base-TX Ethernet	10M/100M/1000M Base-TX Ethernet	10M/100M/1000M Base-TX Ethernet
Reset Button	√	√	√	√
Power	AC 24V ±25%, DC 24V ±25% PoE++ (IEEE 802.3bt)	AC 24V ±25%, DC 24V±25% PoE++ (IEEE 802.3bt)	DC48V±25%, DC24V±15%(DC20V~DC60V) DC-48V±25%, DC-24V±15%(DC-20V~DC-60V) AC24V +/-25%	DC48V±25%, DC24V±15%(DC20V~DC60V) DC-48V±25%, DC-24V±15%(DC-20V~DC-60V) AC24V +/-25%
Ingress Protection	IP66	IP66	IP66	IP66
Working Environment	-40°C ~ 70°C (-40°F ~ 158°F)	-40°C ~ 70°C (-40°F ~ 158°F)	-40°C ~ 70°C (-40°F ~ 158°F)	-40°C ~ 70°C (-40°F ~ 158°F)
Weight	9.69kg (21.4lb)	9.69kg (21.4lb)	13.98kg(30.8lb)	13.95kg(30.8lb)
Power Consumption	16~ 51W	MAX 62W	Max 87.8W	Max 110W
Dimensions	Φ 270mmx496.7mm(Φ 10.6" x 19.6")	Φ 270 x 497mm (Φ 10.6" x 19.6")	280.1mmx364.9mmx505.2mm (Φ 11.0" x 14.4" x 19.9")	280.1mmx364.9mmx505.2mm (Φ 11.0" x 14.4" x 19.9")

Thermal cameras

Thermal cameras detect infrared radiation at wavelengths ranging from 8µm to 14µm and provide images through temperature differences, allowing viewing without visible light. With Smart Intrusion Prevention, the visible camera automatically zooms in and tracks the target when the infrared camera triggers the detection. What's more, the camera has a fire detection function that detects fires. When a fire alarm is triggered, the camera provides both thermal and visible images.



Thermal cameras

Model		TIC6831ER-F50-4X38P	TIC7632EL-F75-2X55G
Appearance			
			
Thermal	Sensor type	Vanadium Oxide Uncooled Focal Plane Arrays	Vanadium Oxide Uncooled Focal Plane Arrays
	Pixel size	17µm	17µm
	Maximum image size	384*288	384*288
	Video frame rate	25fps	25fps
	NETD	≤50mk @ f1.0 @23±3°C	≤50mk @ f1.0 @23±3°C
	Response waveband	8~14µm	8~14µm
	Focus	50mm @F1.0	75mm @F1.0
	Iris	F1.0	F1.0
	Angle of view (H*V)	7.5°*5.8°	5.0°*4.0°
	IFOV	0.34mrad	0.23mrad
Visible light	Sensor	1/1.8" 4MP / CMOS	1/1.8" 4MP / CMOS
	Focus	5.7 ~ 216.6mm	6~ 330mm
	Iris	F1.3 ~ F4.6	F1.3 ~ F4.6
	Minimum illumination	Colour: 0.0005 Lux (F1.3, AGC ON) 0 Lux with IR	Colour: 0.0005 Lux (F1.3, AGC ON) 0 Lux with IR
	S/N	> 55dB	> 55dB
	Defog	Optical Defog & Digital Defog	Optical Defog & Digital Defog
	Day/Night	IR-cut filter with auto switch (ICR)	IR-cut filter with auto switch (ICR)
	Video Frame rate	4MP(2688*1520), Max 60fps	2MP(1920*1080), Max 60fps
	WDR	120dB	120dB
	Angle of view (H)	58.5°~ 2.1°	58.5°~ 1.7°
Pan Range	360°	360°	
Pan Speed	0.1°/s ~ 180°/s	0.1°/s ~ 140°/s	
Tilt Range	-15° ~ 90°	-90° ~ 45°	
Tilt Speed	0.1° ~ 180°/s	0.1° ~ 40°/s	
Auto Tracking	√	√	
ROI (Region of Interest)	√	√	
IR	Up to 150m (492 ft) IR range	Up to 800m (2624.7 ft) laser range	
Video Compression	Ultra265, H.265, H.264, MJPEG	Ultra265, H.265, H.264, MJPEG	
Smart Function	√	√	
OSD font	vector	vector	
The number of OSD	Up to 8 OSDs	Up to 8 OSDs	
Video Streaming	Five streams	Five streams	
Privacy Mask	√	√	
Patrol	√	√	
Preset	1024	1024	
Audio I/O	1 / 1	1 / 1	
Alarm I/O	2 / 1	7 / 2	
BNC	N/A	Supported(Thermal channel)	
Edge Storage	MicroSD, up to 256GB	MicroSD, up to 256GB	
Network Interface	10M/100M Base-TX Ethernet	10M/100M/1000M Base-TX Ethernet+100M/1000M SFP	
Reset Button	√	√	
Power	AC 24V±25%, DC 24V±25%, PoE++ (IEEE802.3bt)	DC 48V±25%, DC 24V±15%, AC 24V±25%	
Working Environment	-40°C ~ +70°C (-40°F ~ 158°F)	-40°C ~ +70°C (-40°F ~ 158°F)	
Ingress Protection	IP66	IP66	
Vandal Resistant	N/A	N/A	
Weight	10.22kg (22.53lb)	15.09kg (33.27lb)	
Power Consumption	Max 57W	Max 119W	
Dimensions(L × W × H)	Φ270mm × 496.7mm (Φ 10.6" × 19.6")	505.2mm × 280.1mm × 364.9mm (19.9" × 11.0" × 14.4")	

Consumer

Not only enterprise and installers pay close attention to video surveillance, but also end-users and families have more requirements about the home security. Uniview releases video doorbell to consumer market for retail/home use. The video doorbell let users always be the first one to know when you have a visitor outside the door by using human body detection and instant notification on the phone. It delivers clear video image no matter day or night. Moreover, it can be widely used in home and retail store with great cost-effective features. It is a new choice for customers and can be applied in many application scenarios.



Consumer

Model	C1L-2WN-G
Appearance	
Axis	3-Axis
Low illumination characteristics	Low-light
Adjustment angle	/
Sensor	1/2.7" 2MP/CMOS
Wide Dynamic Range	Digital WDR
Zoom	Fixed
Lens	Focus: 2.8mm Iris: F2.0 Angle of view(H): 100°
Iris	Fixed
Min. illumination	Color: 0.01Lux (F2.0, AGC ON) 0Lux with IR*
IR	Up to 10m (32ft)
Video Compression	Ultra265, H.265, H.264
Smart Function	√
Frame Rate	1920×1080 30fps
ROI (Region of Interest)	√
9:16 Corridor Mode	/
Video Streaming	Dual streams
Privacy Mask	√
OSD font	vector
The number of OSD	Up to 4 OSD
Audio I/O	Built-in Mic, Built-in Speaker
Alarm I/O	/
BNC	/
Edge Storage	MicroSD, up to 256GB
Network Interface	Wifi, 10M/100M Base-TX Ethernet
Reset Button	√
Power	DC 5V±10%
Working Environment	-10°C ~ 40°C (14°F ~ 104°F)
Ingress Protection	/
Vandal Resistant	/
Weight	0.14kg (0.31lb)
Power Consumption	Max 2.3W
Dimensions(L × W × H)	77.0 x 42.4 x 125.0mm (3.0" × 1.7" × 4.9")

NVR

- Empowered by innovation to provide beneficial features
- Focusing on user experience to ease every operation process
- Born with high quality gene to ensure reliability on device and whole system



NVR308-64R-B

- Multiple innovative video output design: video ports can output pictures individually so live view and playback can be displayed simultaneously
- Support 4K video output, bring much more detail in image than ever
- Up to 12MP HD resolution video record, meet industry-leading requirement
- Professional RAID ensures complete video data storage



NVR301-04E2-P4

- Support Ultra 265/H.265/H.264 video formats, save more storage space
- Record to 4K resolution, play back more detail
- HDMI and VGA simultaneous output, multi-screen simultaneous output
- Support cloud upgrade



Updated U-code Technology

U-code is a deep video compression technology which can reduce up to 90% bitrate in order to save bandwidth and storage space. U-code technology separates moving target and static background with different codec and adjust GOP dynamically, meanwhile keeping good image quality. Recently, U-code supports all triple streams of IP camera, and change frame rate dynamically by video content to reduce more bitrate.

Easy to Use/Maintain

All UNV NVRs support one-click firmware upgrade, upgrade via cloud, and plug & play for installers and end users to use easily. While troubleshooting, it's also easy to output diagnosis log by one-click. Also the NVR provide various methods for system maintain, for example network condition detection, POE port vitalization, USB recovery tools, to ease the process of system repair.

Reliability at Design and Tests

From selective components to design product reliability during research and development, from process control during production to full-process traceability system, Uniview is dedicated to pursuit high quality. All sensor boards in UNV NVR are designed as 2mm thickness to avoid defocus by deformation while using in extremely harsh environment.

Long Distance PoE





Even though the camera's location is hundred meters away from NVR, users can still easily connect camera directly to NVR for both power supply and video streaming. The NVRs in Easy Series support up to 250 meters long distance PoE.





UBS Storage System





UBS is Uniview's patented technology for storage. Traditional NVR manufactures use general file system which is not optimized for video storage application. By operating directly on HDD to improve I/O efficiency and using small block as minimum unit, UBS technology can reduce the risk of data loss in case of system malfunction. Besides, UBS storage system also support disk roaming and precise playback which make surveillance business much easier.



Deep Learning Intelligence





The NVRs can provide smart intrusion prevention, face Identification and metadata which are supported by target recognition based on deep learning algorithm. The Prime Series NVRs can also be connected to non-intelligent cameras by connecting to smart bar externally, thus adding intelligent functions to the camera. It is suitable for people identification applications in buildings, communities, parks, chain stores, gas stations, supermarkets and other different scenarios.





Easy Series						
Model		NVR301-04S3	NVR301-08S3	NVR301-16S3	NVR301-04S3-P4	NVR301-04LS3-P4
Appearance						
Video/Audio Input	IP Video Input	4-ch	8-ch	16-ch	4-ch	4-ch
	Analog Video Input	N/A	N/A	N/A	N/A	N/A
	Input Bandwidth	64 Mbps	64 Mbps	64 Mbps	64 Mbps	64 Mbps
	Audio Input	N/A	N/A	N/A	N/A	N/A
Video/Audio Output	HDMI	1	1	1	1	1
	VGA	1	1	1	1	1
	Audio Output	1	1	1	1	1
	Outgoing Bandwidth	48 Mbps	48 Mbps	48 Mbps	48 Mbps	48 Mbps
	Decoding Capability	4-ch@1080P 1-ch@8MP	8-ch@720P 4-ch@1080P 1-ch@8MP	16-ch@D1 8-ch@720P 4-ch@1080P 1-ch@8MP	4-ch@1080P 1-ch@8MP	4-ch@1080P 1-ch@8MP
Storage	HDD	1 SATA interface	1 SATA interface	1 SATA interface	1 SATA interface	1 SATA interface
External Interface	Network Interface	1 x RJ45 100M	1 x RJ45 100M	1 x RJ45 100M	1 x RJ45 100M	1 x RJ45 100M
	PoE	N/A	N/A	N/A	4 x PoE+	4 x PoE+
	Serial Interface	N/A	N/A	N/A	N/A	N/A
	USB Interface	2 x USB2.0	2 x USB2.0	2 x USB2.0	2 x USB2.0	2 x USB2.0
	Alarm I/O	N/A	N/A	N/A	N/A	N/A
Other	Power Supply	12V DC,1.5A	12V DC,1.5A	12V DC,1.5A	48V/1.35A	48V/1.35A
	Power Consumption	≤5W (without HDD)	≤5W (without HDD)	≤5W (without HDD)	≤9W (without HDD)	≤9W (without HDD)
	Working Environment	-10°C ~ 55°C (14°F ~ 131°F) 10% ~ 90% RH	-10°C ~ 55°C (14°F ~ 131°F) 10% ~ 90% RH	-10°C ~ 55°C (14°F ~ 131°F) 10% ~ 90% RH	-10°C ~ 55°C (14°F ~ 131°F) 10% ~ 90% RH	-10°C ~ 55°C (14°F ~ 131°F) 10% ~ 90% RH
	Dimensions(W×D×H)	260mm×240mm×46mm (10.2"×9.4"×1.8")	260mm×240mm×46mm (10.2"×9.4"×1.8")	260mm×240mm×46mm (10.2"×9.4"×1.8")	260mm×240mm×46mm (10.2"×9.4"×1.8")	205mm×205mm×46mm (8.1"×8.1"×1.8")
	Weight(Without HDD)	≤0.98kg	≤0.98kg	≤0.98kg	≤1.1kg	≤0.6kg

Easy Series						
Model		NVR301-08S3-P8	NVR301-08LS3-P8	NVR301-16LS3-P8	NVR301-04E2	NVR301-08E2
Appearance						
Video/Audio Input	IP Video Input	8-ch	8-ch	16-ch	4-ch	8-ch
	Analog Video Input	N/A	N/A	N/A	N/A	N/A
	Input Bandwidth	64 Mbps	64 Mbps	64 Mbps	64 Mbps	64 Mbps
	Audio Input	N/A	N/A	N/A	1-ch	1-ch
Video/Audio Output	HDMI	1	1	1	1	1
	VGA	1	1	1	1	1
	Audio Output	1	1	1	1	1
	Outgoing Bandwidth	48 Mbps	48 Mbps	48 Mbps	64 Mbps	64 Mbps
	Decoding Capability	8-ch@720P 4-ch@1080P 1-ch@8MP	8-ch@720P 4-ch@1080P 1-ch@8MP	16-ch@D1 8-ch@720P 4-ch@1080P 1-ch@8MP	4-ch@1080P 1-ch@8MP	8-ch@720P 4-ch@1080P 1-ch@8MP
Storage	HDD	1 SATA interface	1 SATA interface	1 SATA interface	1 SATA interface	1 SATA interface
External Interface	Network Interface	1 x RJ45 100M	1 x RJ45 100M	1 x RJ45 100M	1 x RJ45 100M	1 x RJ45 100M
	PoE	8 x PoE+	8 x PoE+	8 x PoE+	N/A	N/A
	Serial Interface	N/A	N/A	N/A	N/A	N/A
	USB Interface	2 x USB2.0	2 x USB2.0	2 x USB2.0	1 x USB2.0 1 x USB3.0	1 x USB2.0 1 x USB3.0
	Alarm I/O	N/A	N/A	N/A	N/A	N/A
Other	Power Supply	52V DC, 1.8A	52V DC, 1.8A	52V DC, 1.8A	12V DC, 1.5A	12V DC, 1.5A
	Power Consumption	≤9W (without HDD)	≤9W (without HDD)	≤9W (without HDD)	≤9W (without HDD)	≤9W (without HDD)
	Working Environment	-10°C ~ 55°C (14°F ~ 131°F) 10% ~ 90% RH	-10°C ~ 55°C (14°F ~ 131°F) 10% ~ 90% RH	-10°C ~ 55°C (14°F ~ 131°F) 10% ~ 90% RH	-10°C ~ 55°C (14°F ~ 131°F) 10% ~ 90% RH	-10°C ~ 55°C (14°F ~ 131°F) 10% ~ 90% RH
	Dimensions(W×D×H)	260mm×240mm×46mm (10.2"×9.4"×1.8")	270mm×205mm×46mm (10.6"×8.1"×1.8")	270mm×205mm×46mm (10.6"×8.1"×1.8")	260mm×240mm×47mm (10.2"×9.4"×1.8")	260mm×240mm×47mm (10.2"×9.4"×1.8")
	Weight(Without HDD)	≤1.1kg	≤0.8 kg	≤0.8 kg	1.3kg	1.3kg



Easy Series					
Model		NVR301-16E2	NVR301-04E2-P4	NVR301-04LE2-P4	NVR301-08E2-P8
Appearance					
Video/Audio Input	IP Video Input	16-ch	4-ch	4-ch	8-ch
	Analog Video Input	N/A	N/A	N/A	N/A
	Input Bandwidth	64 Mbps	80Mbps	80Mbps	80Mbps
	Audio Input	1-ch	1-ch	1-ch	1-ch
Video/Audio Output	HDMI	1	1	1	1
	VGA	1	1	1	1
	Audio Output	1	1	1	1
	Outgoing Bandwidth	64 Mbps	64 Mbps	64 Mbps	64 Mbps
	Decoding Capability	16-ch@D1 8-ch@720P 4-ch@1080P 1-ch@8MP	4-ch@1080P 1-ch@8MP	4-ch@1080P 1-ch@8MP	8-ch@720P 4-ch@1080P 1-ch@8MP
Storage	HDD	1 SATA interface	1 SATA interface	1 SATA interface	1 SATA interface
External Interface	Network Interface	1 x RJ45 100M	1 x RJ45 100M	1 x RJ45 100M	1 x RJ45 100M
	PoE	N/A	4x PoE+	4x PoE+	8 x PoE+
	Serial Interface	N/A	N/A	N/A	N/A
	USB Interface	1 x USB2.0 1 x USB3.0	1 x USB2.0 1 x USB3.0	1 x USB2.0 1 x USB3.0	1 x USB2.0 1 x USB3.0
	Alarm I/O	N/A	N/A	N/A	N/A
Other	Power Supply	12V DC, 1.5A	48V/1.35A	48V/1.35A	52V DC, 1.8A
	Power Consumption	≤9W (without HDD)	≤9W (without HDD)	≤9W (without HDD)	≤9W (without HDD)
	Working Environment	-10°C ~ 55°C (14°F ~ 131°F) 10% ~ 90% RH	-10°C ~ 55°C (14°F ~ 131°F) 10% ~ 90% RH	-10°C ~ 55°C (14°F ~ 131°F) 10% ~ 90% RH	-10°C ~ 55°C (14°F ~ 131°F) 10% ~ 90% RH
	Dimensions(W×D×H)	260mm×240mm×47mm (10.2"×9.4"×1.8")	260mm×240mm×47mm (10.2"×9.4"×1.8")	205mm×205mm×47mm (8.07" × 8.07" × 1.9")	260mm×240mm×47mm (10.2"×9.4"×1.8")
	Weight(Without HDD)	1.3kg	1kg	0.55kg	1kg

Easy Series					
Model		NVR301-08LE2-P8	NVR301-16LE2-P8	NVR301-16LX-P8	NVR301-08LX-P8
Appearance					
Video/Audio Input	IP Video Input	8-ch	16-ch	16-ch	8-ch
	Analog Video Input	N/A	N/A	N/A	N/A
	Input Bandwidth	80Mbps	80Mbps	80Mbps	80 Mbps
	Audio Input	1-ch	1-ch	1-ch	1-ch
Video/Audio Output	HDMI	1	1	1	1
	VGA	1	1	1	1
	Audio Output	1	1	1	1
	Outgoing Bandwidth	64 Mbps	64 Mbps	64 Mbps	64 Mbps
	Decoding Capability	8-ch@720P 4-ch@1080P 1-ch@8MP	16-ch@D1 8-ch@720P 4-ch@1080P 1-ch@8MP	16-ch@720P 8-ch@1080P 2-ch@8MP	8-ch@1080P 2-ch@8MP
Storage	HDD	1 SATA interface	1 SATA interface	1 SATA interface	1 SATA interface
External Interface	Network Interface	1 x RJ45 100M	1 x RJ45 100M	1 x RJ45 100M	1 x RJ45 100M
	PoE	8 x PoE+	8 x PoE+	8 x PoE+	8 x PoE+
	Serial Interface	N/A	N/A	N/A	N/A
	USB Interface	1 x USB2.0 1 x USB3.0	1 x USB2.0 1 x USB3.0	1 x USB2.0 1 x USB3.0	1 x USB2.0 1 x USB3.0
	Alarm I/O	N/A	N/A	N/A	N/A
Other	Power Supply	52V DC, 1.8A	52V DC, 1.8A	52V DC, 1.8A	52V DC, 1.8A
	Power Consumption	≤9W (without HDD)	≤9W (without HDD)	≤9W (without HDD)	≤9W (without HDD)
	Working Environment	-10°C ~ 55°C (14°F ~ 131°F) 10% ~ 90% RH	-10°C ~ 55°C (14°F ~ 131°F) 10% ~ 90% RH	-10°C ~ 55°C (14°F ~ 131°F) 10% ~ 90% RH	-10°C ~ 55°C (14°F ~ 131°F) 10% ~ 90% RH
	Dimensions(W×D×H)	270mm × 205mm × 47mm (10.6"×8.1"×1.9")	270mm × 205mm × 47mm (10.6"×8.1"×1.9")	270mm × 205mm × 47mm (10.6"×8.1"×1.9")	270mm × 205mm × 47mm (10.6"×8.1"×1.9")
	Weight(Without HDD)	0.8kg	0.8kg	0.8kg	0.8kg





Easy Series					
Model		NVR301-08X-P8	NVR301-04LX-P4	NVR301-04X-P4	NVR301-04X
Appearance					
Video/Audio Input	IP Video Input	8-ch	4-ch	4-ch	4-ch
	Analog Video Input	N/A	N/A	N/A	N/A
	Input Bandwidth	80 Mbps	80 Mbps	80 Mbps	64 Mbps
	Audio Input	1-ch	1-ch	1-ch	1-ch
Video/Audio Output	HDMI	1	1	1	1
	VGA	1	1	1	1
	Audio Output	1	1	1	1
	Outgoing Bandwidth	64 Mbps	64 Mbps	64 Mbps	64 Mbps
	Decoding Capability	8-ch@1080P 2-ch@8MP	4-ch@4MP 2-ch@8MP	4-ch@4MP 2-ch@8MP	4-ch@4MP 2-ch@8MP
Storage	HDD	1 SATA interface	1 SATA interface	1 SATA interface	1 SATA interface
External Interface	Network Interface	1 x RJ45 100M	1 x RJ45 100M	1 x RJ45 100M	1 x RJ45 100M
	PoE	8 x PoE+	4 x PoE+	4 x PoE+	N/A
	Serial Interface	N/A	N/A	N/A	N/A
	USB Interface	1 x USB2.0 1 x USB3.0	1 x USB2.0 1 x USB3.0	1 x USB2.0 1 x USB3.0	1 x USB2.0 1 x USB3.0
	Alarm I/O	N/A	N/A	N/A	N/A
Other	Power Supply	52V DC, 1.8A	48V/1.35A	48V/1.35A	12V DC, 1.5A
	Power Consumption	≤9W (without HDD)	≤9W (without HDD)	≤9W (without HDD)	≤9W (without HDD)
	Working Environment	-10°C ~ 55°C (14°F ~ 131°F) 10% ~ 90% RH	-10°C ~ 55°C (14°F ~ 131°F) 10% ~ 90% RH	-10°C ~ 55°C (14°F ~ 131°F) 10% ~ 90% RH	-10°C ~ 55°C (14°F ~ 131°F) 10% ~ 90% RH
	Dimensions(W×D×H)	260mm × 240mm × 47mm (10.2" × 9.5" × 1.8")	205mm × 205mm × 45mm (8.07" × 8.07" × 1.7")	260mm × 240mm × 47mm (10.2" × 9.5" × 1.8")	260mm × 240mm × 47mm (10.2" × 9.5" × 1.8")
	Weight(Without HDD)	1kg	0.55kg	1kg	1.3kg

Easy Series					
Model		NVR301-08X	NVR301-16X	NVR302-09S2	NVR302-16S2
Appearance					
Video/Audio Input	IP Video Input	8-ch	16-ch	9-ch	16-ch
	Analog Video Input	N/A	N/A	N/A	N/A
	Input Bandwidth	64 Mbps	64 Mbps	160Mbps	160Mbps
	Audio Input	1-ch	1-ch	1-ch	1-ch
Video/Audio Output	HDMI	1	1	1	1
	VGA	1	1	1	1
	Audio Output	1	1	1	1
	Outgoing Bandwidth	64 Mbps	64 Mbps	64Mbps	64Mbps
	Decoding Capability	8-ch@1080P 4-ch@4MP 2-ch@8MP	16-ch@720P 8-ch@1080P 4-ch@4MP 2-ch@8MP	9-ch@1080P 8-ch@1080P 2-ch@8MP	16-ch@720P 8-ch@1080P 2-ch@8MP
Storage	HDD	1 SATA interface	1 SATA interface	2 SATA interface	2 SATA interface
External Interface	Network Interface	1 x RJ45 100M	1 x RJ45 100M	2 x RJ45 1000M	2 x RJ45 1000M
	PoE	N/A	N/A	N/A	N/A
	Serial Interface	N/A	N/A	N/A	N/A
	USB Interface	1 x USB2.0 1 x USB3.0	1 x USB2.0 1 x USB3.0	2 x USB2.0 1 x USB3.0	2 x USB2.0 1 x USB3.0
	Alarm I/O	N/A	N/A	N/A	N/A
Other	Power Supply	12V DC, 1.5A	12V DC, 1.5A	12V DC, 3.3A	12V DC, 3.3A
	Power Consumption	≤9W (without HDD)	≤9W (without HDD)	Power Consumption: ≤ 15 W (without HDD)	Power Consumption: ≤ 15 W (without HDD)
	Working Environment	-10°C ~ 55°C (14°F ~ 131°F) 10% ~ 90% RH	-10°C ~ 55°C (14°F ~ 131°F) 10% ~ 90% RH	-10°C ~ 55°C (14°F ~ 131°F) 10% ~ 90% RH	-10°C ~ 55°C (14°F ~ 131°F) 10% ~ 90% RH
	Dimensions(W×D×H)	260mm × 240mm × 47mm (10.2" × 9.5" × 1.8")	260mm × 240mm × 47mm (10.2" × 9.5" × 1.8")	380mm × 315mm × 53mm (15.0" × 12.4" × 2.1")	380mm × 315mm × 53mm (15.0" × 12.4" × 2.1")
	Weight(Without HDD)	1.3kg	1.3kg	≤ 0.98Kg	≤ 0.98Kg



Easy Series

Model		NVR302-32S	NVR302-08S2-P8	NVR302-16S2-P16
Appearance				
Video/Audio Input	IP Video Input	32-ch	8-ch	16-ch
	Analog Video Input	N/A	N/A	N/A
	Input Bandwidth	160 Mbps	160 Mbps	160 Mbps
	Audio Input	1-ch	1-ch	1-ch
Video/Audio Output	HDMI	1	1	1
	VGA	1	1	1
	Audio Output	1	1	1
	Outgoing Bandwidth	64 Mbps	64 Mbps	64 Mbps
	Decoding Capability	32-ch@D1 16-ch@720P 8-ch@1080P 2-ch@8MP	8-ch@1080P 2-ch@8MP	16-ch@720P 8-ch@1080P 2-ch@8MP
Storage	HDD 2 SATA interface	2 SATA interface	2 SATA interface	
External Interface	Network Interface	2 x RJ45 1000M	1 x RJ45 1000M	1 x RJ45 1000M
	PoE	N/A	8 x PoE+	16 x PoE+
	Serial Interface	N/A	N/A	N/A
	USB Interface	2 x USB2.0 1 x USB3.0	1 x USB2.0 1 x USB3.0	1 x USB2.0 1 x USB3.0
	Alarm I/O	N/A	4/1	4/1
Other	Power Supply	12V DC,3.3A	100~240V AC	100~240V AC
	Power Consumption	≤15W (without HDD)	≤10W (without HDD)	≤10W (without HDD)
	Working Environment	-10°C ~ 55°C (14°F ~ 131°F) 10% ~ 90% RH	-10°C ~ 55°C (14°F ~ 131°F) 10% ~ 90% RH	-10°C ~ 55°C (14°F ~ 131°F) 10% ~ 90% RH
	Dimensions(W×D×H)	380mm×315mm×49mm (15.0"×12.4"×1.9")	380mm×315mm×53mm (15.0"×12.4"×2.1")	380mm×315mm×53mm (15.0"×12.4"×2.1")
	Weight(Without HDD)	≤2.48kg	≤2.6kg	≤2.6kg

Easy Series

Model		NVR304-16S	NVR304-32S	NVR304-16S-P16	NVR304-32S-P16
Appearance					
Video/Audio Input	IP Video Input	16-ch	32-ch	16-ch	32-ch
	Analog Video Input	N/A	N/A	N/A	N/A
	Input Bandwidth	160 Mbps	160 Mbps	160 Mbps	160 Mbps
	Audio Input	1-ch	1-ch	1-ch	1-ch
Video/Audio Output	HDMI	1	1	1	1
	VGA	1	1	1	1
	Audio Output	1	1	1	1
	Outgoing Bandwidth	64 Mbps	64 Mbps	64 Mbps	64 Mbps
	Decoding Capability	16-ch@720P 8-ch@1080P 2-ch@8MP	32-ch@D1 16-ch@720P 8-ch@1080P 2-ch@8MP	16-ch@720P 8-ch@1080P 2-ch@8MP	32-ch@D1 16-ch@720P 8-ch@1080P 2-ch@8MP
Storage	HDD 4 SATA interface	4 SATA interface	4 SATA interface	4 SATA interface	
External Interface	Network Interface	2 x RJ45 1000M	2 x RJ45 1000M	1 x RJ45 1000M	1 x RJ45 1000M
	PoE	N/A	N/A	16 x PoE+	16 x PoE+
	Serial Interface	N/A	N/A	N/A	N/A
	USB Interface	2 x USB2.0 1 x USB3.0	2 x USB2.0 1 x USB3.0	1 x USB2.0 1 x USB3.0	1 x USB2.0 1 x USB3.0
	Alarm I/O	N/A	N/A	16/4	16/4
Other	Power Supply	12V DC,5A	12V DC,5A	100~240V AC	100~240V AC
	Power Consumption	≤15W (without HDD)	≤15W (without HDD)	≤15W (without HDD)	≤15W (without HDD)
	Working Environment	-10°C ~ 55°C (14°F ~ 131°F) 10% ~ 90% RH	-10°C ~ 55°C (14°F ~ 131°F) 10% ~ 90% RH	-10°C ~ 55°C (14°F ~ 131°F) 10% ~ 90% RH	-10°C ~ 55°C (14°F ~ 131°F) 10% ~ 90% RH
	Dimensions(W×D×H)	440mm × 344mm × 50mm (17.3" × 13.5" × 2.0")	440mm × 344mm × 50mm (17.3" × 13.5" × 2.0")	400mm × 362mm × 74mm (15.7" × 14.2" × 2.9")	400mm × 362mm × 74mm (15.7" × 14.2" × 2.9")
	Weight(Without HDD)	≤3.15kg	≤3.15kg	≤5kg	≤5kg



Prime Series

Model		NVR316-32R-B	NVR316-64R-B
Appearance			
Video/Audio Input	IP Video Input	32-ch	64-ch
	Analog Video Input	N/A	N/A
	Input Bandwidth	320 Mbps	320 Mbps
	Audio Input	1-ch	1-ch
Video/Audio Output	HDMI	2	2
	VGA	1	1
	Audio Output	1	1
	Outgoing Bandwidth	320 Mbps	320 Mbps
	Decoding Capability	32-ch@720P 16-ch@1080P 4-ch@8MP	64-ch@D1 32-ch@720P 16-ch@1080P 4-ch@8MP
Storage	HDD	16 SATA interfaces 1 eSATA interface	16 SATA interfaces 1 eSATA interface
	Network Interface	2 x RJ45 1000M	2 x RJ45 1000M
External Interface	PoE	N/A	N/A
	Serial Interface	1 x RS-232 1 x RS-485*	1 x RS-232 1 x RS-485
	USB Interface	2 x USB2.0 1 x USB3.0	2 x USB2.0 1 x USB3.0
	Alarm I/O	16/10	16/10
	Power Supply	100~240V AC	100~240V AC
Other	Power Consumption	≤23W (without HDD)	≤23W (without HDD)
	Working Environment	-10°C ~ 55°C (14°F ~ 131°F) 10% ~ 90% RH	-10°C ~ 55°C (14°F ~ 131°F) 10% ~ 90% RH
	Dimensions(W×D×H)	477mm×482mm×131mm (18.8"×19.1"×5.2")	477mm×482mm×131mm (18.8"×19.1"×5.2")
	Weight(Without HDD)	≤8.19kg	≤8.19kg
	Power Supply	100~240V AC	100~240V AC
	Power Consumption	≤23W (without HDD)	≤23W (without HDD)





Pro Series

Model		NVR516-64
Appearance		
Video/Audio Input	IP Video Input	64-ch
	Input Bandwidth	384 Mbps
	Audio Input	1-ch
Video/Audio Output	HDMI	2
	VGA	1
	Audio Output	1
	Outgoing Bandwidth	384 Mbps
	Decoding Capability	64-ch@D1 36-ch@720P 16-ch@1080P 9-ch@4MP 4-ch@4K
Storage	HDD	16 SATA interfaces 1 eSATA interface
External Interface	Network Interface	4 x RJ45 1000M 2 x RJ45 1000M SFP
	PoE	N/A
	Serial Interface	1 x RS232 1 x RS485
	USB Interface	4 x USB3.0
	Alarm I/O	24/8
Other	Power Supply	100~240V AC
	Power Consumption	≤50W (without HDD)
	Working Environment	-10°C ~ 55°C (14°F ~ 131°F) 10% ~ 90% RH
	Dimensions(W×D×H)	482mm×477mm×131mm (19.0"×18.8"×5.1")
	Weight(Without HDD)	≤14.5kg
	Intelligent Card	-
Decode Card	FB-HDMI4-C-NB FB-HDMI6-C-NB	
Disk Enclosure	DEU1008-IN/DEU1016	



Pro Series

Model		NVR516-128	NVR824-128R	NVR824-256R
Appearance				
Video/Audio Input	IP Video Input	128-ch	128-ch	256-ch
	Input Bandwidth	512 Mbps	768 Mbps	768 Mbps
	Audio Input	1-ch	1-ch	1-ch
Video/Audio Output	HDMI	2	2	2
	VGA	1	1	1
	Audio Output	1	1	1
	Outgoing Bandwidth	384 Mbps	768 Mbps	768 Mbps
	Decoding Capability	64-ch@D1 36-ch@720P 16-ch@1080P 9-ch@4MP 4-ch@4K	96-ch@D1 45-ch@720P 20-ch@1080P 5-ch@4K	96-ch@D1 45-ch@720P 20-ch@1080P 5-ch@4K
Storage	HDD	16 SATA interfaces 1 eSATA interface	24 SATA interfaces 1 eSATA interface	24 SATA interfaces 1 eSATA interface
External Interface	Network Interface	4 x RJ45 1000M 2 x RJ45 1000M SFP	4 x RJ45 1000M	4 x RJ45 1000M
	PoE	N/A	N/A	N/A
	Serial Interface	1 x RS232 1 x RS485	1 x RS232 1 x RS485	1 x RS232 1 x RS485
	USB Interface	4 x USB3.0	2 x USB3.0,2 x USB2.0	2 x USB3.0,2 x USB2.0
	Alarm I/O	24/8	24/8	24/8
Other	Power Supply	100~240V AC	100~240V AC	100~240V AC
	Power Consumption	≤50W (without HDD)	≤70W (without HDD)	≤70W (without HDD)
	Working Environment	-10°C ~ 55°C (14°F ~ 131°F) 10% ~ 90% RH	-10°C ~ 50°C (14°F ~ 122°F) 10% ~ 90% RH	-10°C ~ 50°C (14°F ~ 122°F) 10% ~ 90% RH
	Dimensions(W×D×H)	482mm×477mm×131mm (19.0"×18.8"×5.1")	533mm×484.6mm×175.5mm (21.0"×19.1"×6.9")	533mm×484.6mm×175.5mm (21.0"×19.1"×6.9")
	Weight(Without HDD)	≤14.5kg	≤12.5kg	≤12.5kg
	Intelligent Card	-	-	-
Decode Card	FB-HDMI4-C-NB FB-HDMI6-C-NB	-	-	
Disk Enclosure	DEU1008-IN/DEU1016	DEU1008-IN/DEU1016	DEU1008-IN/DEU1016	



WIFI Kit

Model	KIT/NVR301-04LS2-W/4*IPC2122LR3-F40W-E	KIT/NVR301-04LS2-W/4*IPC2124LR3-F40W-D	KIT/NVR301-08LS2-W/4*IPC2122LR3-F40W-E	KIT/NVR301-08LS2-W/6*IPC2122LR3-F40W-E	KIT/NVR301-08LS2-W/8*IPC2122LR3-F40W-E
Appearance					
Type	WIFI Kit	WIFI Kit	WIFI Kit	WIFI Kit	WIFI Kit
IPC	4*IPC2122LR3-F40W-E	4*IPC2124LR3-F40W-D	4*IPC2122LR3-F40W-E	6*IPC2122LR3-F40W-E	8*IPC2122LR3-F40W-E
Resolution	2560×1440 15fps	2560×1440 15fps	2560×1440 15fps	2560×1440 15fps	2560×1440 15fps
Lens	Focus: 4mm Iris: F2.0 Angle of view: 86.5°	Focus: 4mm Iris: F2.0 Angle of view: 86.5°	Focus: 4mm Iris: F2.0 Angle of view: 86.5°	Focus: 4mm Iris: F2.0 Angle of view: 86.5°	Focus: 4mm Iris: F2.0 Angle of view: 86.5°
IR	Up to 30m (98ft)	Up to 30m (98ft)	Up to 30m (98ft)	Up to 30m (98ft)	Up to 30m (98ft)
NVR	1*NVR301-04LS2-W	1*NVR301-04LS2-W	1*NVR301-08LS2-W	1*NVR301-08LS2-W	1*NVR301-08LS2-W
Video Input	4	4	8	8	8
Input Bandwidth	40Mbps	40Mbps	40Mbps	40Mbps	40Mbps
POE	2.4GHz/IEEE 802.11b/g/n	2.4GHz/IEEE 802.11b/g/n	2.4GHz/IEEE 802.11b/g/n	2.4GHz/IEEE 802.11b/g/n	2.4GHz/IEEE 802.11b/g/n
Decoding Capacity	2-ch@4MP 4-ch@1080P	2-ch@4MP 4-ch@1080P	2-ch@4MP 4-ch@1080P	2-ch@4MP 4-ch@1080P	2-ch@4MP 4-ch@1080P

Hybrid Series

Model Name	XVR301-04Q	XVR301-08Q	XVR302-08Q	
Appearance				
Video/Audio Input	IP Video Input	2-ch	4-ch	4-ch
	Analog Video Input	4-ch	8-ch	8-ch
	Input Bandwidth	48 Mbps	56 Mbps	56 Mbps
Video/Audio Output	Audio Input	1-ch, RCA	1-ch, RCA	1-ch, RCA
	HDMI	1	1	1
	VGA	1	1	1
	Audio Output	1-ch, RCA	1-ch, RCA	1-ch, RCA
Encoding	Recording Frame Rate	Main stream: 8MP Lite@8fps(channel1) 5MP Lite@12fps 4MP Lite@15fps 3MP@15fps(channel1) 2MP@15fps 720P@30fps Sub stream: D1@30fps(Max)	Main stream: 8MP Lite@8fps(channel1-channel2) 5MP Lite@12fps 4MP Lite@15fps 3MP@15fps(channel1-channel2) 2MP@15fps 720P@30fps Sub stream: D1@30fps(Max)	Main stream: 8MP Lite@8fps(channel1-channel2) 5MP Lite@12fps 4MP Lite@15fps 3MP@15fps(channel1-channel2) 2MP@15fps 720P@30fps Sub stream: D1@30fps(Max)
	Storage	HDD 1 SATA interface	1 SATA interface	2 SATA interface
External Interface	Network Interface	1 x RJ45 100M	1 x RJ45 100M	1 x RJ45 100M
	PoE	N/A	N/A	N/A
	Serial Interface	N/A	N/A	1 x RS485
	USB Interface	2 x USB2.0	2 x USB2.0	2 x USB2.0
Other	Alarm I/O	N/A	N/A	N/A
	Power Supply	12V DC	12V DC	12V DC
	Power Consumption	≤ 8 W (without HDD)	≤ 8 W (without HDD)	≤ 8 W (without HDD)
	Working Environment	-10°C ~ 55°C (14°F ~ 131°F) 10% ~ 90% RH	-10°C ~ 55°C (14°F ~ 131°F) 10% ~ 90% RH	-10°C ~ 55°C (14°F ~ 131°F) 10% ~ 90% RH
	Dimensions(W×D×H)	260mm×240mm×46mm (10.2"×9.4"×1.8")	260mm×240mm×46mm (10.2"×9.4"×1.8")	380mm×315mm×53mm (15.0"×12.4"×2.1")
Weight(Without HDD)	≤1.1 Kg	≤1.1 Kg	≤1.9kg	

AI-XVR



Model Name		XVR302-08U-IF	XVR302-16Q-IF
Appearance			
Video/Audio Input	IP Video Input	8-ch	8-ch
	Analog Video Input	8-ch	16-ch
	Input Bandwidth	80 Mbps	72 Mbps
	Audio Input	1-ch, RCA	1-ch, RCA
Video/Audio Output	HDMI	1	1
	VGA	1	1
	Audio Output	1-ch, RCA	1-ch, RCA
	Outgoing Bandwidth	64 Mbps	80 Mbps
Encoding	Recording Frame Rate	Main stream: 8MP@8fps 5MP@12fps 4MP@15fps 3MP@18fps 2MP@25fps 720P@30fps Sub stream: D1@30fps (Max)	Main stream: 8MP Lite@8fps(channel1-channel4) 5MP Lite@12fps 4MP Lite@15fps 3MP@15fps(channel1-channel4) 2MP@15fps 720P@30fps Sub stream: D1@30fps (Max)
Storage	HDD	2 SATA interface	2 SATA interface
External Interface	Network Interface	1 x RJ45 1000M	1 x RJ45 1000M
	PoE	N/A	N/A
	Serial Interface	1 x RS485	1 x RS485
	USB Interface	1 x USB2.0 1 x USB3.0	1 x USB2.0 1 x USB3.0
	Alarm I/O	8/4	4/1
Other	Power Supply	12V DC	12V DC
	Power Consumption	≤12W (without HDD)	≤12W (without HDD)
	Working Environment	-10°C ~ 55°C (14°F ~ 131°F) 10% ~ 90% RH	-10°C ~ 55°C (14°F ~ 131°F) 10% ~ 90% RH
	Dimensions(W×D×H)	380mm×318mm×53.5mm (14.96" × 12.51" × 2.1")	380mm×318mm×53.5mm (14.96" × 12.51" × 2.1")
	Weight(Without HDD)	≤2kg	≤2kg

VMS

UNV VMS products are powerful and highly reliable video surveillance management platforms which offer a comprehensive solution by connecting with other UNV products including IP camera, NVR, decoder, network keyboard, etc. They are compatible with ONVIF-compliant IP cameras and open to integrate with other systems. UNV VMS products have been widely used in various scenarios such as public security, finance, transportation, electric power, energy, education, and healthcare, and in diverse scenarios including large parks and buildings.



VMS





Item	VMS-B180-A	Unicorn	VMS-B800-A
Appearance			
Number of connected cameras per server	250 devices or 500 channels	1,000 devices or 2,000 channels	2,000 devices or 10,000 channels
Video management	Device management	IPC, NVR, network keyboard, cloud devices, alarm control panels, access control, smart devices, decoder	IPC, NVR, network keyboard, cloud devices, alarm control panels, access control, smart devices, decoder (built-in, expanded)
	Numbers of online users	50	300
	Numbers of roles per user	16	16
	Number of mobile clients	50	64
	Bandwidth of video input per server	512Mbps	512Mbps
Bandwidth of video output per server	384Mbps	384Mbps	1536Mbps
Decoding	Video compression	Ultra265, H.265, H.264	Ultra265, H.265, H.264
	Decoding	2x4K, 16x1080P, 24x720P, 30xD1 (Local HMI Client)	4x4K, 16x1080p, 36x720p, 64xD1
	Decoding card (optional)	N/A	Max 2 cards supported; models: HDMI4-C and HDMI6-C
Storage	HDD installation	1 HDD, for picture storage (3.5", up to 14TB)	Hot-swappable HDDs; Support 16 HDDs (3.5", up to 14TB for each)
	Bandwidth of video storage per server	N/A	512Mbps
Disk enclosure (optional)	N/A	Max 2 disk enclosures supported; models: DEU1008 and DEU1016	N/A
Play control	Play control	1 / 3 / 4 / 5 / 6 / 7 / 8 / 9 / 10 / 13 / 16 / 17 / 25 / 32 / 36 / 64 windows display	1 / 3 / 4 / 5 / 6 / 7 / 8 / 9 / 10 / 13 / 16 / 17 / 25 / 32 / 36 / 64 windows display
	Corridor format	Corridor format	Corridor format
Playback	Up to 3 auxiliary monitors	Up to 3 auxiliary monitors	Up to 3 auxiliary monitors
	Play NVR recordings	Play NVR recordings and central recordings	Play NVR recordings and central recordings (IP SAN required)
	Synchronous playback up to 16 channels on single client	Synchronous playback up to 16 channels on single client	Synchronous playback up to 16 channels on single client
	Speed: -256, -128, -64, -32, -16, -8, -4, -2, -1, 1/4, 1/2, 1, 2, 4, 8, 16, 32, 64, 128, 256	Speed: -256, -128, -64, -32, -16, -8, -4, -2, -1, 1/4, 1/2, 1, 2, 4, 8, 16, 32, 64, 128, 256	Speed: -256, -128, -64, -32, -16, -8, -4, -2, -1, 1/4, 1/2, 1, 2, 4, 8, 16, 32, 64, 128, 256
Interface	Network	4x10M/100M/1000M Base-T adaptive Ethernet interfaces	4x10M/100M/1000M Base-T adaptive Ethernet interfaces; 2x1000M SFP optical interfaces
	USB	4xUSB3.0	4xUSB3.0
	HDMI	1xHDMI	2xHDMI
	VGA	1xVGA	1xVGA
	Serial	1xRS232 (RJ45), 1xRS485 (RJ45)	1xRS232 (RJ45), 1xRS485 (RJ45)
	Alarm input/output	24xalarm inputs, 8xalarm outputs	24xalarm inputs, 8xalarm outputs
	Power supply	100-240V AC, with power switch	100-240V AC, with power switch
	Expansion	N/A	1xpower module; 1xeSATA interface; 2xminiSAS interfaces; 2xdecoding cards
Others	Operation system	Linux	Linux
	Power consumption	≤ 40W	≤ 50W (not including HDD); ≤ 165W (including HDD)
	Operating temperature	-10°C to 55°C (14°F to 131°F)	-10°C to 55°C (14°F to 131°F)
	Operating humidity	10% to 90% (non-condensing)	10% to 90% (non-condensing)
	Weight	≤ 4.1 Kg (without HDD)	≤ 10.0 Kg (without HDD)
Dimensions(DxWxH)	440 mm × 399.50 mm × 48 mm (17.2"×15.7"×1.8")	477.1mm×481.6mm×130.5mm (18.8"×19"×5.1")	482mm×551mm×87mm (19"×21.7"×3.4")

Professional Storage



Nebula, with high performance, high reliability, high availability, high density, high scalability and high usability, is a new-generation unified network storage developed especially for video surveillance. Integrating a wide range of features such as iSCSI storage, RAID processing, failover protection, permanent data protection and cutting-edge disk management technology, Nebula offers concurrent block access performance (iSCSI), and thus forms a comprehensive solution to storage in video surveillance.





Single Controller

Model	VX1616-C	VX1624-C	VX1824-V2	VX1848-V2	VX3060-V2@S
Appearance					
Controller	Single	Single	Single	Single	Single
Video Input	Up to 320 channels /640Mbps	Up to 320 channels /640Mbps	Up to 512 channels /1024Mbps	Up to 512channels /1024Mbps	Up to 512channels /1024Mbps
Front-end Service Interface	3-port 10/100/1000 Mbps Ethernet interface 4-port 10/100/1000 Mbps Ethernet interface module (optional)	3-port 10/100/1000 Mbps Ethernet interface 4-port 10/100/1000 Mbps Ethernet interface module (optional)	5-port 10/100/1000 Mbps Ethernet interface 4-port 10/100/1000 Mbps Ethernet interface module (optional) 2-port 10 GE SFP + interface module (optional) 4-port 10 GE SFP + interface module (optional)	5-port 10/100/1000 Mbps Ethernet interface 4-port 10/100/1000 Mbps Ethernet interface module (optional) 2-port 10 GE SFP + interface module (optional) 4-port 10 GE SFP + interface module (optional)	4-port 10/100/1000 Mbps Ethernet interface module (optional) 2-port 10 GE SFP + interface module (optional) 4-port 10 GE SFP + interface module (optional)
Back-end Expansion Interface	N/A	N/A	2-port 4×12 Gbps Mini SAS HD	2-port 4×12 Gbps Mini SAS HD	2-port 4×12 Gbps Mini SAS HD
RAID	JBOD and RAID 0,1, 5, 6 Dedicated hot-spare disk and global hot-spare disk	JBOD and RAID 0,1, 5, 6 Dedicated hot-spare disk and global hot-spare disk	JBOD and RAID 0,1, 10, 5, 50, 6 Dedicated hot-spare disk and global hot-spare disk	JBOD and RAID 0,1, 10, 5, 50, 6 Dedicated hot-spare disk and global hot-spare disk	JBOD and RAID 0,1, 10, 5, 50, 6 Dedicated hot-spare disk and global hot-spare disk
Protocol	iSCSI	iSCSI	iSCSI	iSCSI	iSCSI
Processor	Intel 64-bit multi-core processor	Intel 64-bit multi-core processor	Intel 64-bit multi-core processor	Intel 64-bit multi-core processor	Intel 64-bit multi-core processor
Memory	4GB	4GB	8 GB, up to 64 GB	8 GB, up to 64 GB	8 GB, up to 64 GB
HDD	16 SATA interfaces	24 SATA interfaces	24 SATA interfaces	48 SATA interfaces	60 SATA interfaces
Features	Optimized Cache Algorithm Redundant Modular Design Anti-Dust & Sulfide Alarm Anti-Vibration HDD Module Fault Sector Repair Two Level of Remap S.M.A.R.T. Pre-Copy Tech No Sense Partial Rebuild Copy Rebuild Cache Data Safe Box	Optimized Cache Algorithm Redundant Modular Design Anti-Dust & Sulfide Alarm Anti-Vibration HDD Module Fault Sector Repair Two Level of Remap S.M.A.R.T. Pre-Copy Tech No Sense Partial Rebuild Copy Rebuild Cache Data Safe Box	Optimized Cache Algorithm Redundant Modular Design Anti-Dust & Sulfide Alarm Anti-Vibration HDD Module Fault Sector Repair Two Level of Remap S.M.A.R.T. Pre-Copy Tech No Sense Partial Rebuild Copy Rebuild Cache Data Safe Box	Optimized Cache Algorithm Redundant Modular Design Anti-Dust & Sulfide Alarm Anti-Vibration HDD Module Fault Sector Repair Two Level of Remap S.M.A.R.T. Pre-Copy Tech No Sense Partial Rebuild Copy Rebuild Cache Data Safe Box	Optimized Cache Algorithm Redundant Modular Design Anti-Dust & Sulfide Alarm Anti-Vibration HDD Module Fault Sector Repair Two Level of Remap S.M.A.R.T. Pre-Copy Tech No Sense Partial Rebuild Copy Rebuild Cache Data Safe Box
Power Supply	1+1 Redundant	1+1 Redundant	1+1 Redundant	1+1 Redundant	2+1 Redundant
Fan	1+1 Redundant	1+1 Redundant	1+1 Redundant	1+1 Redundant	1+1 Redundant
Consumption	Controller enclosure: <200 W (fully configured)	Controller enclosure: <280 W (fully configured)	Controller enclosure: <350 W (fully configured)	Controller enclosure: <600 W (fully configured)	Controller enclosure: <900W (fully configured)
Weight	Controller enclosure: Fully configured: <24 kg	Controller enclosure: Fully configured: <32 kg	Controller enclosure :Fully configured :< 43 kg	Controller enclosure: Fully configured: <60 kg	Controller enclosure: Fully configured: <93kg
Dimensions(H×W×D)	Controller enclosure: 131mm×481.6mm×583mm	Controller enclosure: 175.0mm×481.6mm×583.0mm	Controller enclosure: 175.0mm×481.6mm×589.0mm	Controller enclosure: 178mm×481.6mm×801mm	Controller enclosure: 178mm×482mm×981mm
Disk Enclosure	N/A	N/A	DE1824-V2	DE1848-V2	DE3160-V2@S

Dual Controller

Model	VX3024-V2	VX3048-V2	VX3060-V2
Appearance			
Controller	Dual	Dual	Dual
Video Input	Up to 512 channels /1024Mbps	Up to 512 channels /1024Mbps	Up to 512 channels /1024Mbps
Front-end Service Interface	10-port 10/100/1000 Mbps Ethernet interface 4-port 10/100/1000 Mbps Ethernet interface module (optional) 2-port 10 GE SFP + interface module (optional) 4-port 10 GE SFP + interface module (optional)	10-port 10/100/1000 Mbps Ethernet interface 4-port 10/100/1000 Mbps Ethernet interface module (optional) 2-port 10 GE SFP + interface module (optional) 4-port 10 GE SFP + interface module (optional)	10-port 10/100/1000 Mbps Ethernet interface 4-port 10/100/1000 Mbps Ethernet interface module (optional) 2-port 10 GE SFP + interface module (optional) 4-port 10 GE SFP + interface module (optional)
Back-end Expansion Interface	4-port 4*12 Gbps Mini SAS HD	4-port 4*12 Gbps Mini SAS HD	4-port 4*12 Gbps Mini SAS HD
RAID	JBOD and RAID 0,1,10, 5, 50,6 Dedicated hot-spare disk and global hot-spare disk	JBOD and RAID 0,1,10, 5, 50,6 Dedicated hot-spare disk and global hot-spare disk	JBOD and RAID 0,1,10, 5, 50,6 Dedicated hot-spare disk and global hot-spare disk
Protocol	iSCSI	iSCSI	iSCSI
Processor	Intel 64-bit multi-core processor	Intel 64-bit multi-core processor	Intel 64-bit multi-core processor
Memory	Default 16 GB (Up to 128 GB optional)	Default 16 GB (Up to 128 GB optional)	Default 16 GB (Up to 128 GB optional)
HDD	24 SATA/SAS/NL SAS interfaces	48 SATA/SAS/NL SAS interfaces	60 SATA/SAS/NL SAS interfaces
Features	Optimized Cache Algorithm Redundant Modular Design Anti-Dust & Sulfide Alarm Anti-Vibration HDD Module Fault Sector Repair Two Level of Remap S.M.A.R.T. Pre-Copy Tech No Sense Partial Rebuild Copy Rebuild Cache Data Safe Box	Optimized Cache Algorithm Redundant Modular Design Anti-Dust & Sulfide Alarm Anti-Vibration HDD Module Fault Sector Repair Two Level of Remap S.M.A.R.T. Pre-Copy Tech No Sense Partial Rebuild Copy Rebuild Cache Data Safe Box	Optimized Cache Algorithm Redundant Modular Design Anti-Dust & Sulfide Alarm Anti-Vibration HDD Module Fault Sector Repair Two Level of Remap S.M.A.R.T. Pre-Copy Tech No Sense Partial Rebuild Copy Rebuild Cache Data Safe Box
Power Supply	2 default (1+1)	2 default (1+1)	3 default (2+1)
Fan	1+1 Redundant	1+1 Redundant	1+1 Redundant
Consumption	Controller enclosure: <550W (fully configured)	Controller enclosure: <700W (fully configured)	Controller enclosure: <1000W (fully configured)
Weight	Controller enclosure: Fully configured: <45kg	Controller enclosure: Fully configured: <68 kg	Controller enclosure: Fully configured: <96kg
Dimensions(H×W×D)	Controller enclosure: 175mm×482mm×589mm	Controller enclosure: 178mm×482mm×801mm	Controller enclosure: 178mm×482mm×981mm
Disk Enclosure	DE3124-V2	DE3148-V2	DE3160-V2

Expansion Unit

Model	DE1824-V2	DE1848-V2	DE3124-V2
Appearance			
Expand Interface	2-port 4*12 Gbps Mini SAS HD	2-port 4*12 Gbps Mini SAS HD	4-port 4*12Gbps Mini SAS HD
Management Interface	2 Serial port	2 Serial port	2 Serial port
HDD	24HDDs	48HDDs	24HDDs
Consumption	250W (fully loaded)	410W (fully loaded)	270W (fully loaded)
Weight	Fully loaded: <38kg	Fully loaded: <60kg	Fully loaded: <40kg
Dimensions (H×W×D)	482mm×589mm×175mm	482mm×801mm×178mm	482.0mm×589.0mm×175.0 mm

Model	DE3148-V2	DE3160-V2	DE3160-V2@S
Appearance			
Expand Interface	4-port 4*12Gbps Mini SAS HD	4-port 4*12Gbps Mini SAS HD	2-port 4*12Gbps Mini SAS HD
Management Interface	2 Serial port	2 Serial port	2 Serial port
HDD	48HDDs	60HDDs	60HDDs
Consumption	450W (fully loaded)	700W (fully loaded)	700W (fully loaded)
Weight	Fully loaded: <61kg	Fully loaded: <92kg	Fully loaded: <90kg
Dimensions (H×W×D)	482.0mm×801.0mm×178.0 mm	480.6mm×981.0mm×178.0 mm	480.6mm×981.0mm×178.0 mm

Display & Control

- **Precision Manufacturing**
High quality manufacturing ensures stability and reliability
- **Perfect Display Effect**
Give you immersive visual experience
- **Excellent Structural Design**
Easy to install and maintain
- **Professional Video Wall Controller**
Powerful display control and management functions



LCD Video Wall

Model	MW-A46-B1	MW-A49-B1	MW-A55-B1
Appearance			
Product	46" LCD Video Wall	49" LCD Video Wall	55" LCD Video Wall
Pixel Pitch(mm)	0.53025(H)×0.17675(V)	0.559(H)×0.1865(V)	0.63(H)×0.21(V)
Backlight	LED	LED	LED
Resolution	1920×1080	1920×1080	1920×1080
Bezel Width	3.5mm	3.5mm	3.5mm
Display Color	16.7M	16.7M	16.7M
Brightness	500cd/m2	500cd/m2	500cd/m2
Contrast	4000:1	4000:1	4000:1
Response Time	8ms	8ms	8ms
Viewing Angle	178°(H) 178°(V)	178°(H) 178°(V)	178°(H) 178°(V)
Signal Input	1×VGA, 1×DVI, 1×HDMI, 1×USB, 1×RS-232 IN, 1×IR	1×VGA, 1×DVI, 1×HDMI, 1×USB, 1×RS-232 IN, 1×IR	1×VGA, 1×DVI, 1×HDMI, 1×USB, 1×RS-232 IN, 1×IR
Signal output	1×RS-232 OUT	1×RS-232 OUT	1×RS-232 OUT
Dimension(W×H×D)	1022mm×577mm×125mm (40.2"×22.7"×4.9")	1078mm×608mm×124mm (42.4"×23.9"×4.9")	1214mm×685mm×126mm (47.8"×27.0"×4.9")
Consumption	141.6W	136W	220W
Power Supply	AC100-240V 50/60Hz	AC100-240V 50/60Hz	AC100-240V 50/60Hz
Weight	22.5kg(49.6lb)	23.5kg(51.8lb)	24.5kg(54.0lb)
Work Condition	0~+40°C(32°F~104°F)/20%-90%RH altitudes≤5000m	0~+40°C(32°F~104°F)/20%-90%RH altitudes≤5000m	0~+40°C(32°F~104°F)/20%-90%RH altitudes≤5000m
Lifespan	50000h	50000h	50000h

LED Displays

Model	XE Series				
	MW7209-E-U	MW7212-E-U	MW7214-E-U	MW7215-E-U	MW7216-E-U
Appearance					
Product	0.9mm pixel pitch mini LED	1.2mm Indoor fine pixel LED	1.4mm Indoor fine pixel LED	1.5mm Indoor fine pixel LED	1.6mm Indoor fine pixel LED
Pixel Pitch	0.9mm	1.24mm	1.45mm	1.55mm	1.67mm
LED Type	IMD 4 in 1 LED	Surface mounted trinity LED	Surface mounted trinity LED	Surface mounted trinity LED	Surface mounted trinity LED
Module Resolution(W×H)	172×192	128×145	110×124	102×116	96×108
Module Size(W×H)	160mm×180mm (6.3"×7.1")	160mm×180mm (6.3"×7.1")	160mm×180mm (6.3"×7.1")	160mm×180mm (6.3"×7.1")	160mm×180mm (6.3"×7.1")
Cabinet Size(W×H×D)	640mm×360mm×54.5mm (25.2"×14.2"×2.1")	640mm×360mm×54.5mm (25.2"×14.2"×2.1")	640mm×360mm×54.5mm (25.2"×14.2"×2.1")	640mm×360mm×54.5mm (25.2"×14.2"×2.1")	640mm×360mm×54.5mm (25.2"×14.2"×2.1")
Modules/Cabinet(W×H)	4×2	4×2	4×2	4×2	4×2
Cabinet Resolution(W×H)	688×384	512×290	440×248	408×232	384×216
Cabinet Weight(pcs)	6.95kg(15.3lb)	6.95kg(15.3lb)	6.95kg(15.3lb)	6.95kg(15.3lb)	6.95kg(15.3lb)
Cabinet Area	0.2304m ²	0.2304m ²	0.2304m ²	0.2304m ²	0.2304m ²
Pixel Density	1146666dots/m ²	644444dots/m ²	473790dots/m ²	410833dots/m ²	360000dots/m ²
Brightness(cd/m2)	50-700(adjustable)	50-800(adjustable)	50-800(adjustable)	50-1500(adjustable)	50-800(adjustable)
Cabinet Flatness	≤0.1mm	≤0.1mm	≤0.1mm	≤0.1mm	≤0.1mm
Cabinet Material	Die-cast aluminum	Die-cast aluminum	Die-cast aluminum	Die-cast aluminum	Die-cast aluminum
Viewing Angle	160°(H) 140°(V)	160°(H) 140°(V)	160°(H) 140°(V)	160°(H) 140°(V)	160°(H) 140°(V)
Brightness Uniformity	≥97%	≥97%	≥97%	≥97%	≥97%
Color Uniformity	≥97%	≥97%	≥97%	≥97%	≥97%
Contrast	≥4000:1	≥4000:1	≥4000:1	≥4000:1	≥4000:1
Color Temperature	3000K-10000K adjustable	3000K-10000K adjustable	3000K-10000K adjustable	3000K-10000K adjustable	3000K-10000K adjustable
Refresh Rate	3840Hz	1920-3840Hz	1920-3840Hz	1980Hz	1920-3840Hz
Gray Scale Processing	14bit	16bit	14bit	14bit	14bit
Scanning Mode	1/48 scan	1/29 scan	1/31 scan	1/29 scan	1/27 scan
Driving Mode	Constant Current Driving	Constant Current Driving	Constant Current Driving	Constant Current Driving	Constant Current Driving
Frame Rate	50/60Hz	50/60Hz	50/60Hz	50/60Hz	50/60Hz
Input Voltage	AC100~240V	AC100~240V	AC100~240V	AC100~240V	AC100~240V
Input Power(avg)	282W/m ²	230W/m ²	217W/m ²	210W/m ²	180W/m ²
Input Power(max)	716W/m ²	630W/m ²	600W/m ²	590W/m ²	530W/m ²
Maintenance Mode	Front Maintenance	Front Maintenance	Front Maintenance	Front Maintenance	Front Maintenance
Power/signal Redundancy	Support	Optional	Optional	Optional	Optional
LED Lifespan	100000h	100000h	100000h	100000h	100000h
Ingress Protection	IP5X	IP5X	IP5X	IP5X	IP5X
Work Condition	-10~+40°C(14°F~104°F)/8-85%RH	-10~+40°C(14°F~104°F)/8-85%RH	-10~+40°C(14°F~104°F)/8-85%RH	-10~+40°C(14°F~104°F)/8-85%RH	-10~+40°C(14°F~104°F)/8-85%RH
Storage Condition	-10~+55°C(14°F~131°F)/10-90%RH	-10~+55°C(14°F~131°F)/10-90%RH	-10~+55°C(14°F~131°F)/10-90%RH	-10~+55°C(14°F~131°F)/10-90%RH	-10~+55°C(14°F~131°F)/10-90%RH



LED Displays

Model	XL Series				
	MW7212-E-BL-U	MW7214-E-BL-U	MW7215-E-BL-U	MW7216-E-BL-U	MW7218-E-DL-U
Appearance					
Product	1.2mm Indoor fine pixel LED	1.4mm Indoor fine pixel LED	1.5mm Indoor fine pixel LED	1.6mm Indoor fine pixel LED	1.8mm Indoor fine pixel LED
Pixel Pitch	1.24mm	1.45mm	1.55mm	1.67mm	1.87mm
LED Type	Surface mounted trinity LED	Surface mounted trinity LED	Surface mounted trinity LED	Surface mounted trinity LED	Surface mounted trinity LED
Module Resolution(W×H)	128×145	110×124	102×116	96×108	85×96
Module Size(W×H)	160mm×180mm (6.3"×7.1")	160mm×180mm (6.3"×7.1")	160mm×180mm (6.3"×7.1")	160mm×180mm (6.3"×7.1")	160mm×180mm (6.3"×7.1")
Cabinet Size(W×H×D)	640mm×360mm×54.5mm (25.2"×14.2"×2.1")	640mm×360mm×54.5mm (25.2"×14.2"×2.1")	640mm×360mm×54.5mm (25.2"×14.2"×2.1")	640mm×360mm×54.5mm (25.2"×14.2"×2.1")	640mm×360mm×54.5mm (25.2"×14.2"×2.1")
Modules/Cabinet(W×H)	4×2	4×2	4×2	4×2	4×2
Cabinet Resolution(W×H)	512×290	440×248	408×232	384×216	340×192
Cabinet Weight(pcs)	6.95kg(15.3lb)	6.95kg(15.3lb)	6.95kg(15.3lb)	6.95kg(15.3lb)	6.95kg(15.3lb)
Cabinet Area	0.2304m ²	0.2304m ²	0.2304m ²	0.2304m ²	0.2304m ²
Pixel Density	644444dots/m ²	473790dots/m ²	410833dots/m ²	360000dots/m ²	283333dots/m ²
Brightness(cd/m2)	50-800(adjustable)	50-800(adjustable)	50-1500(adjustable)	50-800(adjustable)	50-800(adjustable)
Cabinet Flatness	≤0.1mm	≤0.1mm	≤0.1mm	≤0.1mm	≤0.1mm
Cabinet Material	Die-cast aluminum	Die-cast aluminum	Die-cast aluminum	Die-cast aluminum	Die-cast aluminum
Viewing Angle	160°(H) 140°(V)	160°(H) 140°(V)	160°(H) 140°(V)	160°(H) 140°(V)	160°(H) 140°(V)
Brightness Uniformity	≥97%	≥97%	≥97%	≥97%	≥97%
Color Uniformity	≥97%	≥97%	≥97%	≥97%	≥97%
Contrast	≥4000:1	≥4000:1	≥4000:1	≥4000:1	≥4000:1
Color Temperature	3000K-10000K adjustable	3000K-10000K adjustable	3000K-10000K adjustable	3000K-10000K adjustable	3000K-10000K adjustable
Refresh Rate	1920-3840Hz	1920Hz	1980Hz	1920Hz	1920Hz
Gray Scale Processing	16bit	14bit	14bit	14bit	14bit
Scanning Mode	1/29 scan	1/31 scan	1/29 scan	1/27 scan	1/32 scan
Driving Mode	Constant Current Driving	Constant Current Driving	Constant Current Driving	Constant Current Driving	Constant Current Driving
Frame Rate	50/60Hz	50/60Hz	50/60Hz	50/60Hz	50/60Hz
Input Voltage	AC100-240V	AC100-240V	AC100-240V	AC100-240V	AC100-240V
Input Power(avg)	230W/m ²	217W/m ²	210W/m ²	180W/m ²	150W/m ²
Input Power(max)	630W/m ²	600W/m ²	590W/m ²	530W/m ²	415W/m ²
Maintenance Mode	Front Maintenance	Front Maintenance	Front Maintenance	Front Maintenance	Front Maintenance
Power/signal Redundancy	-	-	-	-	-
LED Lifespan	100000h	100000h	100000h	100000h	100000h
Ingress Protection	IP5X	IP5X	IP5X	IP5X	IP5X
Work Condition	-10~+40°C(14°F~104°F)/8-85%RH	-10~+40°C(14°F~104°F)/8-85%RH	-10~+40°C(14°F~104°F)/8-85%RH	-10~+40°C(14°F~104°F)/8-85%RH	-10~+40°C(14°F~104°F)/8-85%RH
Storage Condition	-10~+55°C(14°F~131°F)/10-90%RH	-10~+55°C(14°F~131°F)/10-90%RH	-10~+55°C(14°F~131°F)/10-90%RH	-10~+55°C(14°F~131°F)/10-90%RH	-10~+55°C(14°F~131°F)/10-90%RH

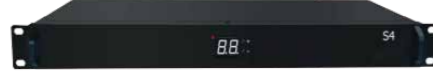

LED Displays

Model	XA Series			
	MW7215-A-FL-U	MW7216-A-FL-U	MW7218-A-FL-U	MW7225-A-FL-U
Appearance				
Product	1.5mm Indoor fine pixel LED	1.6mm Indoor fine pixel LED	1.8mm Indoor fine pixel LED	2.5mm Indoor fine pixel LED
Pixel Pitch	1.5mm	1.6mm	1.8mm	2.5mm
LED Type	Surface mounted trinity LED	Surface mounted trinity LED	Surface mounted trinity LED	Surface mounted trinity LED
Module Resolution(W×H)	152×152	144×144	128×128	96×96
Module Size(W×H)	240mm×240mm (9.4"×9.4")	240mm×240mm (9.4"×9.4")	240mm×240mm (9.4"×9.4")	240mm×240mm (9.4"×9.4")
Cabinet Size(W×H×D)	480mm×480mm×59.6mm (18.9"×18.9"×2.3")	480mm×480mm×59.6mm (18.9"×18.9"×2.3")	480mm×480mm×59.6mm (18.9"×18.9"×2.3")	480mm×480mm×59.6mm (18.9"×18.9"×2.3")
Modules/Cabinet(W×H)	2×2	2×2	2×2	2×2
Cabinet Resolution(W×H)	304×304	288×288	256×256	192×192
Cabinet Weight(pcs)	5.18kg(11.4lb)	5.18kg(11.4lb)	5.18kg(11.4lb)	5.18kg(11.4lb)
Cabinet Area	0.2304m ²	0.2304m ²	0.2304m ²	0.2304m ²
Pixel Density	401111dots/m ²	360000dots/m ²	284444dots/m ²	160000dots/m ²
Brightness(cd/m2)	50-700(adjustable)	50-700(adjustable)	50-700(adjustable)	50-700(adjustable)
Cabinet Flatness	≤0.15mm	≤0.15mm	≤0.15mm	≤0.15mm
Cabinet Material	Die-cast aluminum	Die-cast aluminum	Die-cast aluminum	Die-cast aluminum
Viewing Angle	160°(H) 140°(V)	160°(H) 140°(V)	160°(H) 140°(V)	160°(H) 140°(V)
Brightness Uniformity	≥97%	≥97%	≥97%	≥97%
Color Uniformity	≥97%	≥97%	≥97%	≥97%
Contrast	≥4000:1	≥4000:1	≥4000:1	≥4000:1
Color Temperature	3000K-10000K adjustable	3000K-10000K adjustable	3000K-10000K adjustable	3000K-10000K adjustable
Refresh Rate	3840Hz	3840Hz	3840Hz	3840Hz
Gray Scale Processing	14bit	14bit	14bit	14bit
Scanning Mode	1/38 scan	1/48 scan	1/64 scan	1/48 scan
Driving Mode	Constant Current Driving	Constant Current Driving	Constant Current Driving	Constant Current Driving
Frame Rate	50/60Hz	50/60Hz	50/60Hz	50/60Hz
Input Voltage	AC100-240V	AC100-240V	AC100-240V	AC100-240V
Input Power(avg)	395W/m ²	352W/m ²	386W/m ²	309W/m ²
Input Power(max)	629W/m ²	634W/m ²	192W/m ²	130W/m ²
Maintenance Mode	Front/Rear Maintenance	Front/Rear Maintenance	Front/Rear Maintenance	Front/Rear Maintenance
Power/signal Redundancy	-	-	-	-
LED Lifespan	100000h	100000h	100000h	100000h
Ingress Protection	IP5X	IP5X	IP5X	IP5X
Work Condition	-10~+40°C(14°F~104°F)/8-85%RH	-10~+40°C(14°F~104°F)/8-85%RH	-10~+40°C(14°F~104°F)/8-85%RH	-10~+40°C(14°F~104°F)/8-85%RH
Storage Condition	-10~+55°C(14°F~131°F)/10-90%RH	-10~+55°C(14°F~131°F)/10-90%RH	-10~+55°C(14°F~131°F)/10-90%RH	-10~+55°C(14°F~131°F)/10-90%RH





LED Displays

Model	Sending Box	
	UNV-S4	UNV-MCTRL600
Appearance		
	1×DVI, 1×HDMI, 1×HDMI_LOOP	1×DVI, 1×HDMI
Input Resolution	1920×1200 pixels maximum	1920×1200 pixels maximum
Video Source Frame Rate	60Hz(support auto-adjustment)	60Hz(support auto-adjustment)
Control Area	2.3million pixels maximum (W 4096 pixels, H 2560 pixels)	2.3million pixels maximum (W 4096 pixels, H 2560 pixels)
Output Signal	4×gigabit ethernet interface	4×gigabit ethernet interface
Transmission Distance	CAT5≤140m, CAT6≤170m, optical fiber: no limitation	CAT5≤140m, CAT6≤170m, optical fiber: no limitation
Transmission Mode	Frame mode (Gigabit Ethernet) with CRC	Frame mode (Gigabit Ethernet) with CRC
Configuration Interface	1×USB 2.0	1×USB 2.0
Dimensions(W×H×D)	440mm×44mm×240mm(17.3"×1.7"×9.4")	482mm×44mm×269mm(19"×1.7"×10.6")
Weight	2.0kg(4.4lb)	2.9kg(6.4lb)
Power Supply	AC 100~240V	AC 100~240V
Power Consumption	20W	16W



Monitor

Model	Entry Series		
	MW3222-L	MW3222-V	MW3224-V
Appearance			
Product	22" LED Monitor	22" LED Monitor	24" LED Monitor
Panel Size	21.5 inch	21.5 inch	23.8 inch
Pixel Pitch(mm)	0.2482(H)×0.2482(V)	0.2482(H)×0.2482(V)	0.2745(H)×0.2745(V)
Backlight	LED	LED	LED
Resolution	1920×1080	1920×1080	1920×1080
Brightness	250cd/m2	250cd/m2	250cd/m2
Contrast	1000:1	1000:1	1000:1
Response time	5ms	5ms	14ms
Display Color	16.7M	16.7M	16.7M
Viewing Angle	170°(H) 160°(V)	170°(H) 160°(V)	178°(H) 178°(V)
Video Input	1×HDMI, 1×VGA	1×HDMI, 1×VGA	1×HDMI, 1×VGA
Audio Input	-	1×3.5mm mini-jack	1×3.5mm mini-jack
Speaker	-	2×2W	2×2W
Language	11 (English, French, German, Italian, Simplified Chinese, Traditional Chinese, Korean, Japanese, Espanola, Portuguese, Russian)	11 (English, French, German, Italian, Simplified Chinese, Traditional Chinese, Korean, Japanese, Espanola, Portuguese, Russian)	11 (English, French, German, Italian, Simplified Chinese, Traditional Chinese, Korean, Japanese, Espanola, Portuguese, Russian)
Wall Mount(mm)	100×100	100×100	100×100
Power Supply	DC 12V, 2A	DC 12V, 2A	DC 12V, 2.5A
Consumption (Standard)	20W	20W	30W
Consumption (Standby)	0.5W	0.5W	0.5W
Work Condition	0~40°C(32°F~104°F)/20%~85%RH	0~40°C(32°F~104°F)/20%~85%RH	0~40°C(32°F~104°F)/20%~85%RH
Storage Condition	-20~60°C(-4°F~140°F)/10%~90%RH	-20~60°C(-4°F~140°F)/10%~90%RH	-20~60°C(-4°F~140°F)/10%~90%RH
Dimension(W×H×D)	510mm×305mm×35mm (20.1"×12.0"×1.4") 510mm×381mm×190mm(with pedestal) (20.1"×15.0"×7.5")	510mm×305mm×35mm (20.1"×12.0"×1.4") 510mm×381mm×190mm(with pedestal) (20.1"×15.0"×7.5")	541mm×322mm×39mm (21.3"×12.7"×1.5") 541mm×407mm×210mm(with pedestal) (21.3"×16.0"×8.3")
Weight(net/gross)	2.5kg(5.5lb)/3.5kg(7.7lb)	2.3kg(5.1lb)/3.8kg(8.4lb)	3.3kg(7.3lb)/4.2kg(9.3lb)

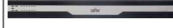

Monitor

Model	Entry Series		Pro Series	
	MW3227-L	MV3232-V	MW3232-E	MW3243-E
Appearance				
Product	27" LED Monitor	32" LED Monitor	32" LED Monitor	43" LED Monitor
Panel Size	27 inch	31.5 inch	32 inch	43 inch
Pixel Pitch(mm)	0.317(H)×0.317(V)	0.364(H)×0.364(V)	0.364(H)×0.364(V)	0.49(H)×0.49(V)
Backlight	LED	LED	LED	LED
Resolution	1920×1080	1920×1080	1920×1080	1920×1080
Brightness	250cd/m2	350cd/m2	300cd/m2	300cd/m2
Contrast	3000:1	1400:1	1400:1	1200:1
Response time	14ms	6ms	8ms	8ms
Display Color	16.7M	16.7M	16.7M	16.7M
Viewing Angle	178°(H) 178°(V)	178°(H) 178°(V)	178°(H) 178°(V)	178°(H) 178°(V)
Video Input	1×HDMI, 1×VGA	1×HDMI, 1×DVI, 1×VGA	1×DVI, 1×VGA, 1×HDMI	1×DVI, 1×VGA, 1×HDMI
Audio Input	-	1×3.5mm mini-jack	1×3.5mm mini-jack	1×3.5mm mini-jack
Speaker	-	2×2W	2×3W	2×3W
Language	8 (English, Spanish ,Korea, Simplified Chinese, France, Russia, Japanese, German)	8 (English, French, German, Simplified Chinese, Korean, Japanese, Espanola, Russian)	12 (English, French, German, Italian, Simplified Chinese, Espanol, Portuguese, Russian, Korean, Nederlands, Turkic, Polskl)	12 (English, French, German, Italian, Simplified Chinese, Espanol, Portuguese, Russian, Korean, Nederlands, Turkic, Polskl)
Wall Mount(mm)	100×100	100×100	200×240/200×300	400×300/400×400
Power Supply	DC 12V, 3A	AC 100~240V, 50/60Hz	AC 100~240V, 50/60Hz	AC 100~240V, 50/60Hz
Consumption (Standard)	36W	45W	<70W	<80W
Consumption (Standby)	0.5W	0.5W	<1W	<1W
Work Condition	0~+40°C(32°F~104°F)/20%~85%RH	0~+40°C(32°F~104°F)/20%~85%RH	0~+50°C(32°F~122°F)/10%~90%RH	0~+50°C(32°F~122°F)/10%~90%RH
Storage Condition	-10~+50°C(14°F~122°F)/10%~90%RH	-10~+60°C(-14°F~140°F)/10~90%RH	-10~+60°C(-14°F~140°F)/10%~90%RH	-10~+60°C(-14°F~140°F)/10%~90%RH
Dimension(W×H×D)	615mm×364mm×46mm (24.2"×14.3"×1.8") 615mm×456mm×225mm(with pedestal) (24.2"×18.0"×8.9")	725mm×426mm×50mm (28.5"×16.8"×2.0")	750mm×453mm×48mm (29.5"×17.8"×1.9")	994mm×586mm×50mm (39.1"×23.1"×2.0")
Weight(net/gross)	3.9kg(8.6lb)/4.5kg(9.9lb)	6.3kg(13.9lb)/8.0kg(17.6lb)	12.0kg(16.5lb)/13.5kg(29.8lb)	18.2kg(40.1lb)/22.1kg(48.7lb)

Decoder ADU87XX-E

Model	ADU8706-E	ADU8709-E	ADU8712-E
Appearance			
Product	6-Channel High Definition Video Decoder	9-Channel High Definition Video Decoder	12-Channel High Definition Video Decoder
Output Channel	6×HDMI	9×HDMI	12×HDMI
Output Format	4K:3840×2160@30Hz, WUXGA:1920×1200@60Hz, 1080P:1920×1080@60Hz, UXGA:1600×1200@60Hz, WXGA+:1440×900@60Hz, SXGA:1280×1024@60Hz, 720P:1280×720@60Hz, XGA:1024×768@60Hz		
Input Channel	2×HDMI, 2×DVI		
HDMI Input Format	4K:3840×2160@30Hz, 1080P:1920×1080@60Hz, 1080P:1920×1080@50Hz, UXGA:1600×1200@60Hz, WXGA+:1440×900@60Hz, SXGA:1280×1024@60Hz, 720P:1280×720@60Hz, 720P:1280×720@50Hz, XGA:1024×768@60Hz		
DVI Input Format	1080P:1920×1080@60Hz, 1080P:1920×1080@50Hz, UXGA:1600×1200@60Hz, WXGA+:1440×900@60Hz, SXGA:1280×1024@60Hz, 720P:1280×720@60Hz, 720P:1280×720@50Hz, XGA:1024×768@60Hz		
Video Stream Format	H.265, H.264, MPEG4		
Decoding Capability	8*12MP@20/8*4K@30/32*1080P@30/72*720P@30	12*12MP@20/12*4K@30/48*1080P@30/108*720P@30	16*12MP@20/16*4K@30/64*1080P@30/144*720P@30
Display Split	1/2/3/4/5/6/7/8/9/10/13/16		
Serial Interface	1×RS-232, 1×RS485		
Network Interface	2×RJ-45, 10M/100M/1000M adaptive Ethernet Interfaces		
Power Supply	100V~240V AC, 50Hz/60Hz		
Consumption	60W		
Work Condition	-10~+55°C(14°F~131°F)/10%~90%RH		
Weight	4kg(8.8lb)		
Dimensions (W×H×D)	440mm×48mm×340mm(17.3"×1.9"×13.4")		



Video Wall Controller

Model	DMC8000	
Appearance		
Product	Video Wall Controller	
Case	3U	5U
Dimensions(W×H×D)	442mm×132mm×469mm(17.4"×5.2"×18.5")	
Weight	4kg(8.8lb)	5kg(11.0lb)
Consumption	<300W	<650W
Host Power Consumption	<60W	<60W
Card Slots	4	6
Master Control Interface	1×GE, 4×RS-232, 4×RS-485, 2×USB 3.0, 1×Reset	
Power Supply	100V~240V AC, 50Hz/60Hz	
Work Condition	0°C~+50°C(32°F~122°F)	
Signal Input Cards	HDMI, DVI, VGA cards	
HDMI, DVI, VGA Input Format	XGA:1024×768@60Hz, 720P:1280×720@60Hz, SXGA:1280×1024@60Hz, 1080P:1920×1080@60Hz, UXGA:1600×1200@60Hz, 1680×1050@60Hz	
Signal Output Cards	DVI Cards	
DVI Output Format	XGA:1024×768@60Hz, 720P:1280×720@60Hz, SXGA:1280×1024@60Hz, UXGA:1600×1200@60Hz, WXGA+:1440×900@60Hz, 1080P:1920×1080@60Hz, WUXGA:1920×1200@60Hz	
Main Control Panel	SC80-MPUS (Main control panel)	
Optional Cards	SC80-H08E (HDMI input card with 8 ports)	
	SC80-D08E (DVI input card with 8 ports)	
	SC80-V08E (VGA input card with 8 ports)	
	SC80-D08D (DVI output card with 8 ports)	

Decoder DC5301

Model	DC5301-IN
Appearance	
Product	Single Channel High Definition Video Decoder
HDMI Output	1 ch 3840×2160@60, 3840×2160@30, 1920×1080@60, 1920×1080@50, 1600×1200@60, 1440×900@60, 1366×768@60, 1280×1024@60, 1280×720@60, 1024×720@50, 1024×768@60
VGA Output	1 ch 1920×1080@60, 1920×1080@50, 1600×1200@60, 1440×900@60, 1366×768@60, 1280×1024@60, 1280×720@60, 1024×720@50, 1024×768@60
CVBS Output	PAL
Video Decoding Resolution	12MP, 8MP, 6MP, 5MP, 4MP, 3MP, 1080P, 1080i, 960P, 720P, D1, CIF
Decoding Capability	2×12MP@30, 4×8MP@30, 8×1080P@60, 16×1080P@30
Display Split	1/2/3/4/7/9/16/25/36
Audio I/O	1/1
Audio Compression	G.711 μ , G.711A
Network Interface	2×RJ-45 10M/100M/1000M adaptive ethernet
USB Interface	1×USB2.0
Serial Interface	1×RS-232, 1×RS-485/422
Alarm I/O	4/2
Power Supply	12V DC
Consumption	15 W
Work Condition	-10~+60°C(-14°F~140°F)/10% ~ 90%RH
Weight	2.0kg(4.4lb)
Dimensions(W×H×D)	189mm×40mm×250mm(7.4×1.6×9.8)

Decoder DC550X-E

Model	DC5504-E	DC5506-E	DC5509-E
Appearance			
Product	4-Channel High Definition Video Decoder	6-Channel High Definition Video Decoder	9-Channel High Definition Video Decoder
Input Channel	2×HDMI		
DVI Input	3840×2160(4K)@30HZ,1920×1080(1080P)@60HZ,1920×1080(1080P)@50HZ,1600×1200(UXGA)@60HZ,1440×900(WXGA)@60HZ,1280×1024(SXGA)@60HZ,1280×720(720P)@60HZ,1280×720(720P)@50HZ,1024×768(XGA)@60HZ		
Output Channel	4×HDMI	6×HDMI	9×HDMI
DVI Output	3840×2160(4K)@30HZ,1920×1200(WUXGA)@60HZ,1920×1080(1080P)@60HZ,1600×1200(UXGA)@60HZ,1440×900(WXGA+)@60HZ,1280×1024(SXGA)@60HZ,1280×720(720P)@60HZ,1024×768(XGA)@60HZ		
Video Stream Format	H.265, H.264, MPEG4		
Decoding Capability	4×8MP@30,16×1080P@30,36×720P@30,64×D1	6×8MP@30,24×1080P@30,54×720P@30,96×D1	9×8MP@30,36×1080P@30,81×720P@30,144×D1
Display Split	1/2/3/4/6/7/8/9/16		
Serial Interface	1×RS-232, 1×RS485		
Network Interface	1×RJ-45, 10M/100M/1000M adaptive Ethernet Interfaces		
Power Supply	100V ~ 240V AC; 50Hz/60Hz		
Consumption	20W	24W	31W
Work Condition	-10~+55(14°F~131°F)/10% ~ 90%RH		
Weight	3.28kg(7.2lb)	3.30kg(7.3lb)	3.37kg(7.4lb)
Dimensions(W×H×D)	440mm×44mm×339mm(17.3"×1.7"×13.3")		

Keyboard

Model	KB-1100
Appearance	
Product	Network keyboard
Joystick	Four-dimensional joystick
Network Interface	1×RJ-45 10M/100M adaptive ethernet
USB Interface	1×USB2.0
Serial Interface	1×RS-232, 2×RS-485
Power Supply	12V DC
Consumption	5W
Work Condition	-10~+55°C(14°F~131°F)/10%~90%RH
Dimensions(W×H×D)	440mm×47mm×270mm(17.3×1.9×10.6)
Weight	1.0kg(2.2lb)

Accessories**IP Camera Bracket****Switch****Network Cable**

IP Camera Bracket

Box camera mount

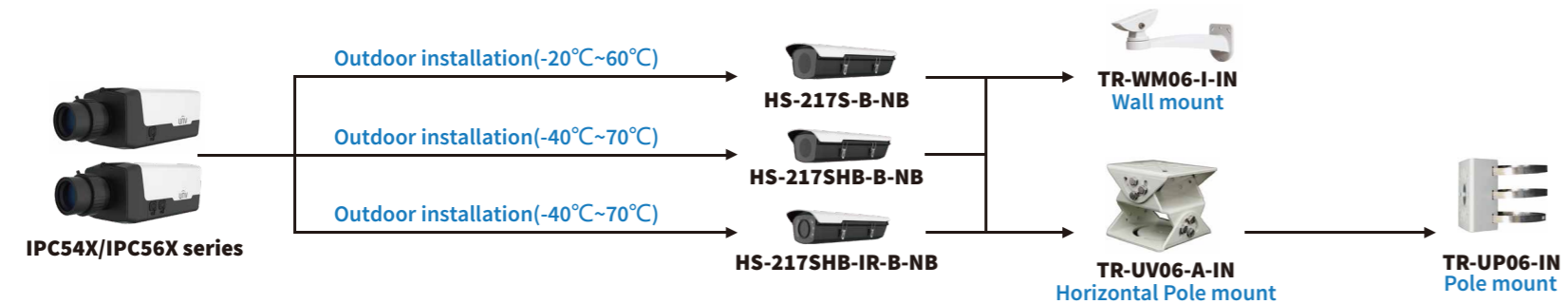
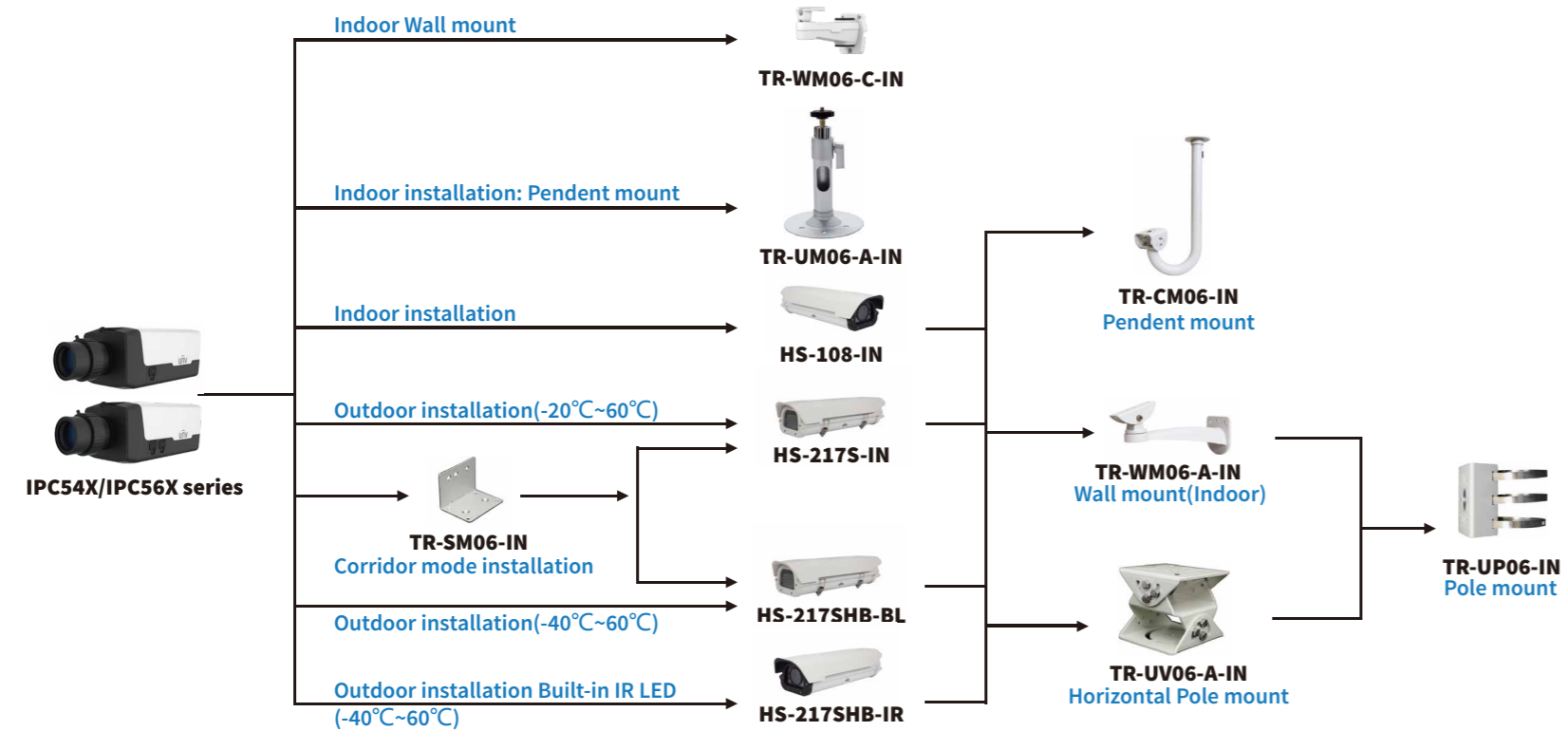

IP Camera Bracket

Dome camera mount

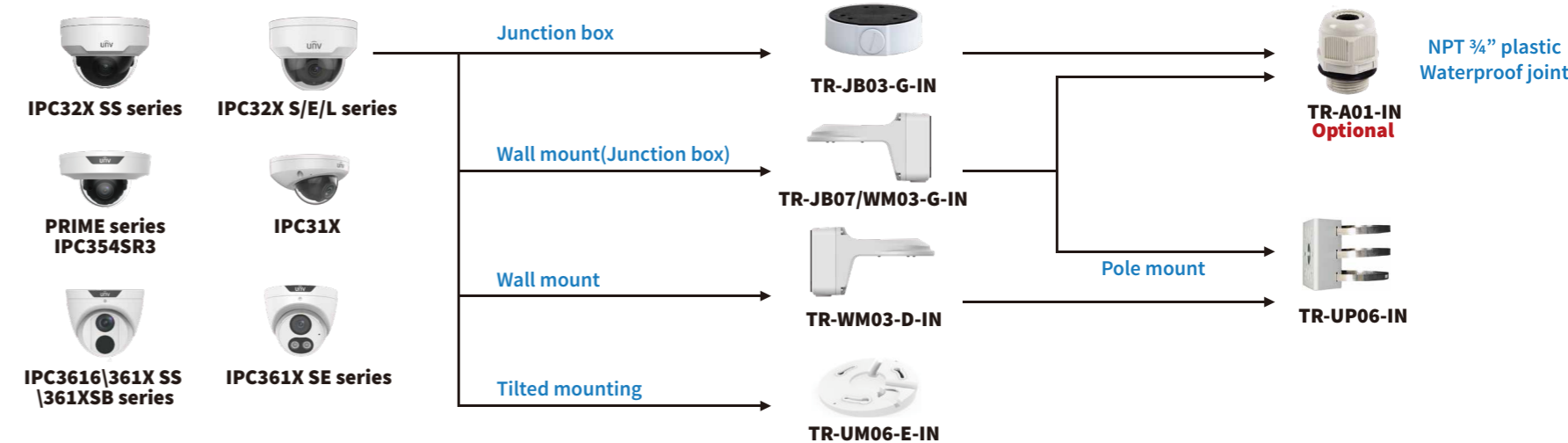
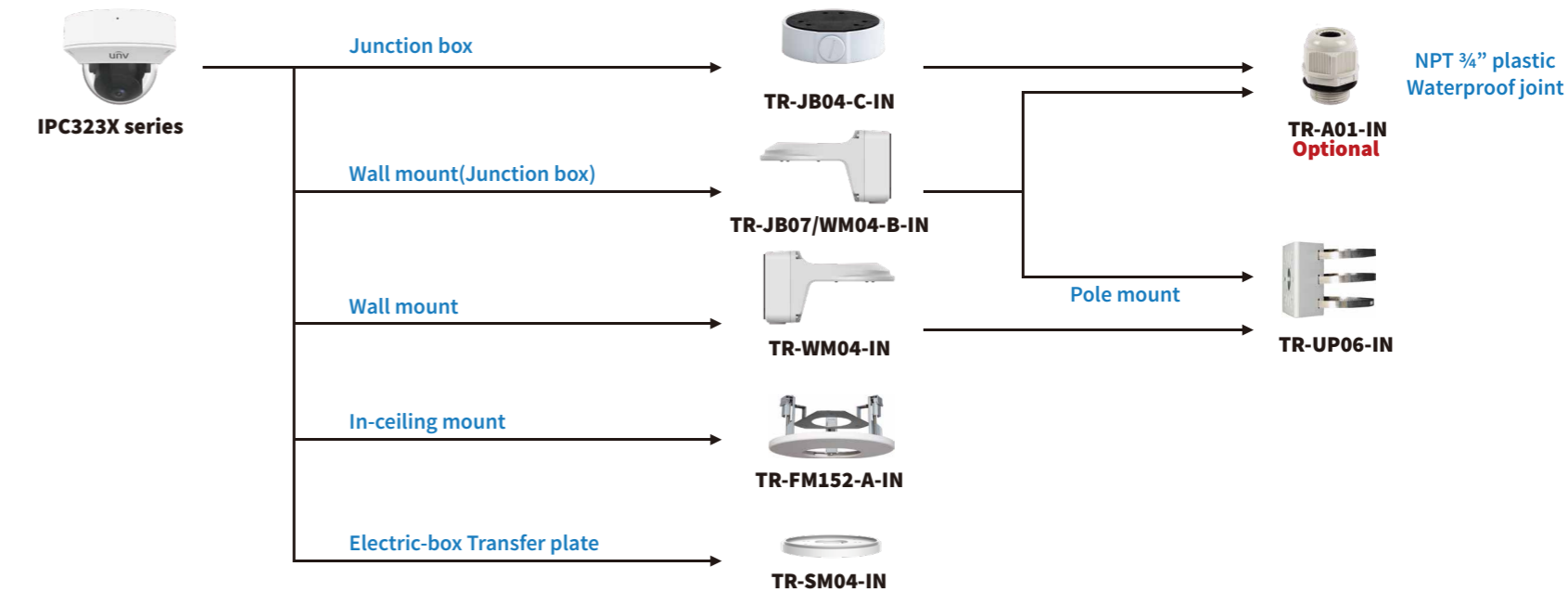

IP Camera Bracket

Dome camera mount

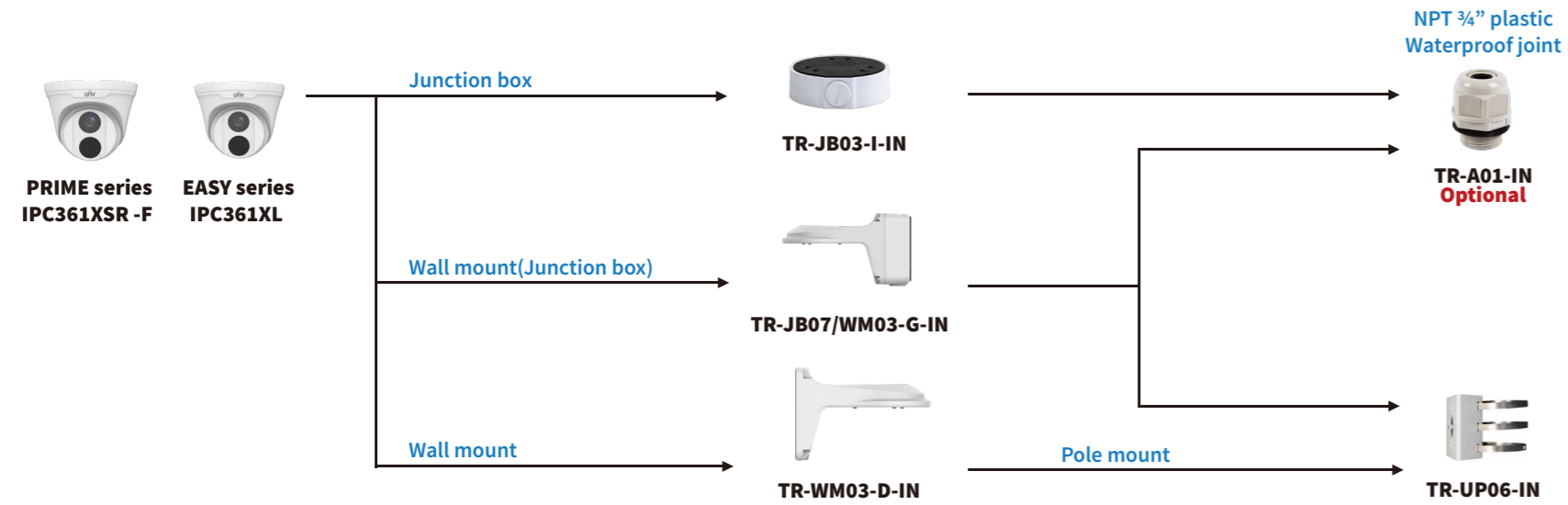

IP Camera Bracket

Fisheye camera mount

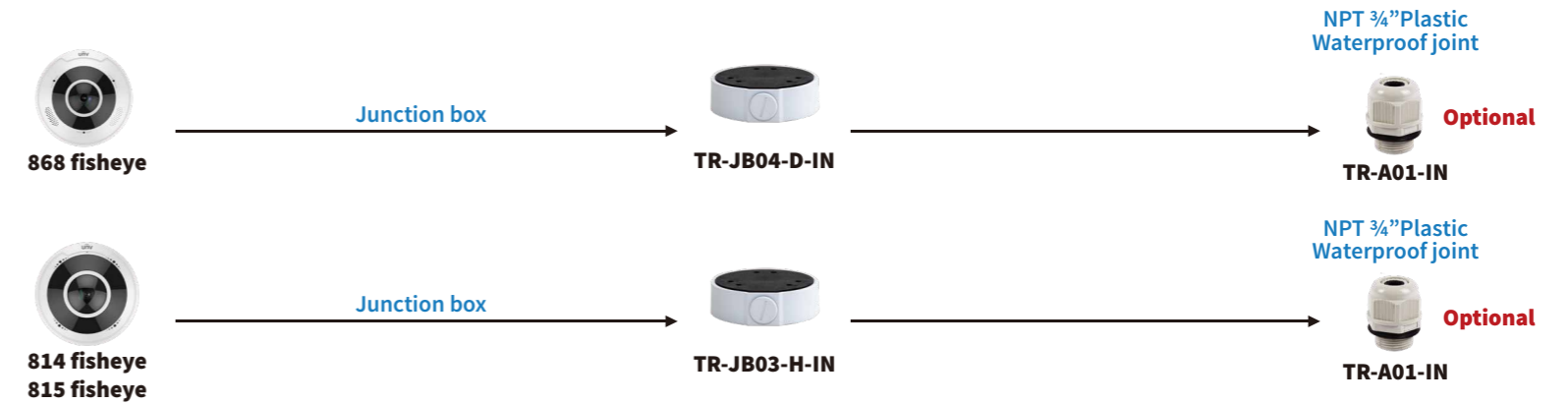

Dome camera Indoor pendant mount

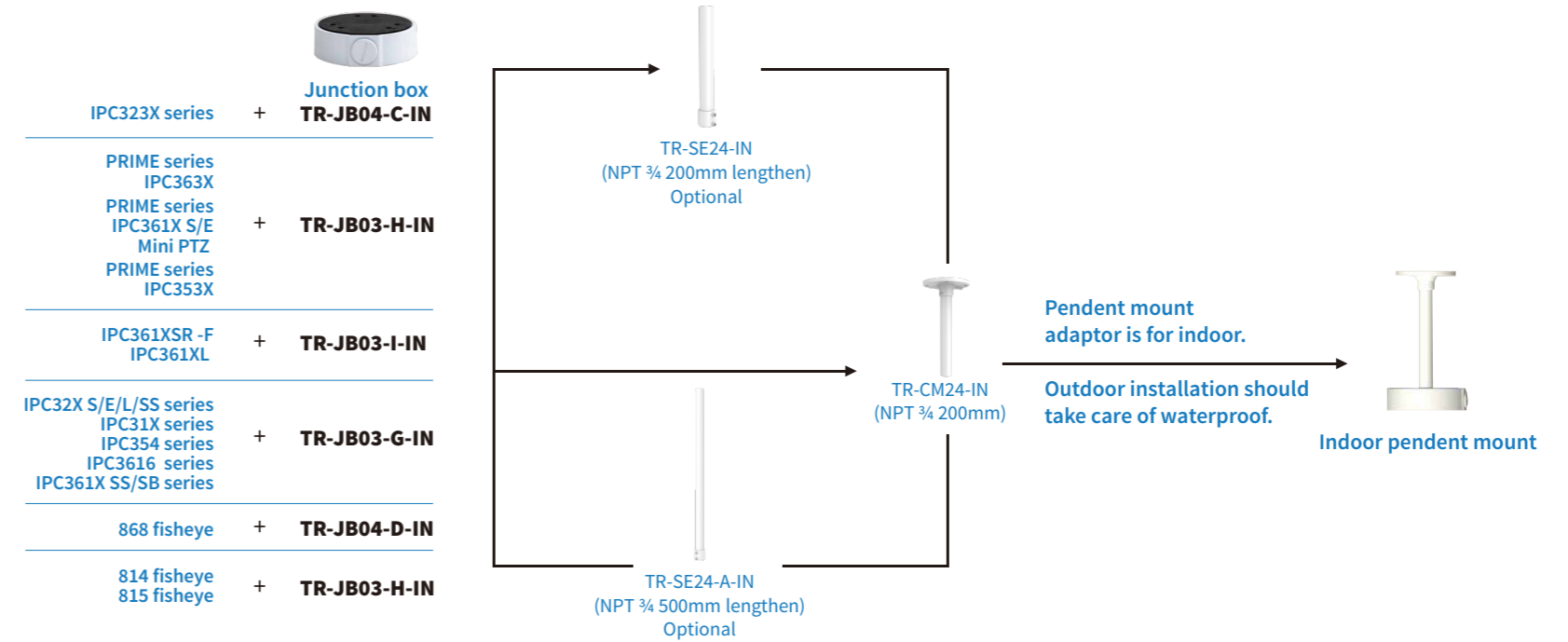
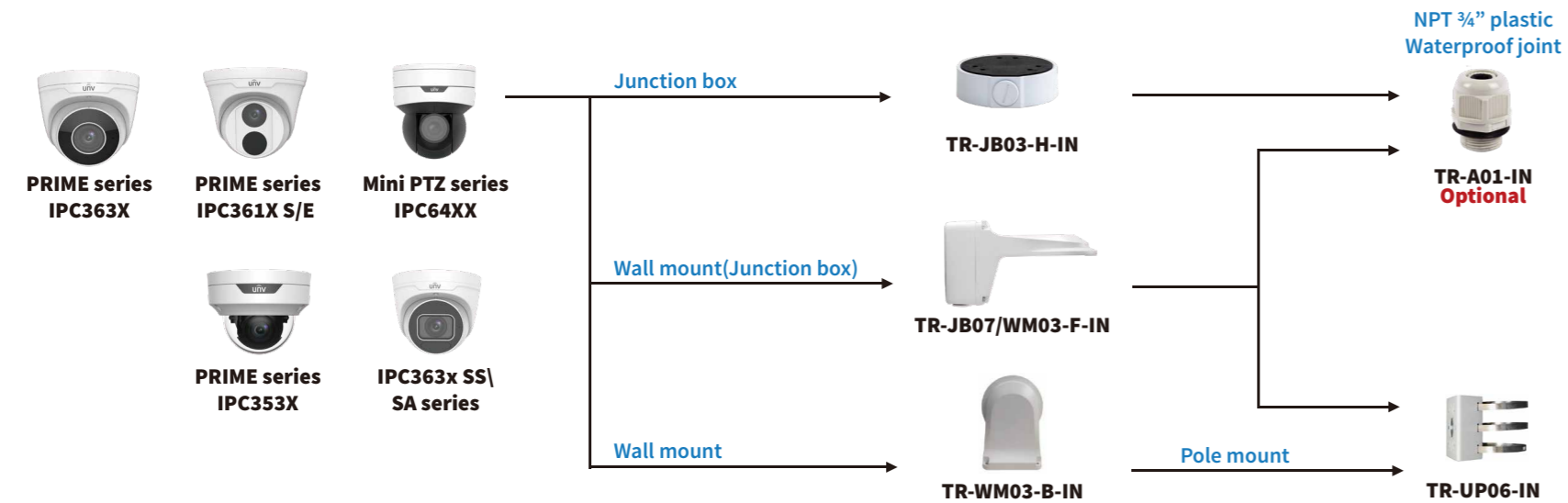

IP Camera Bracket

Bullet camera mount

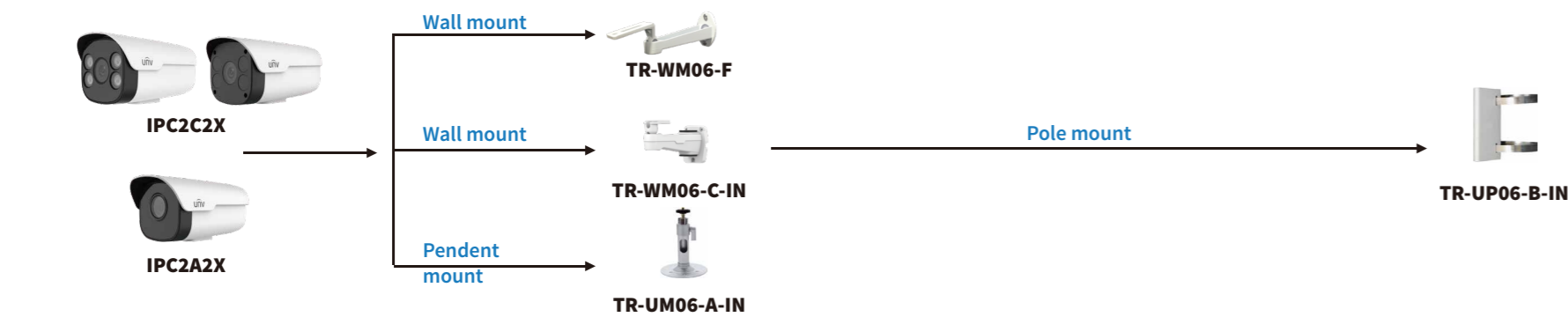
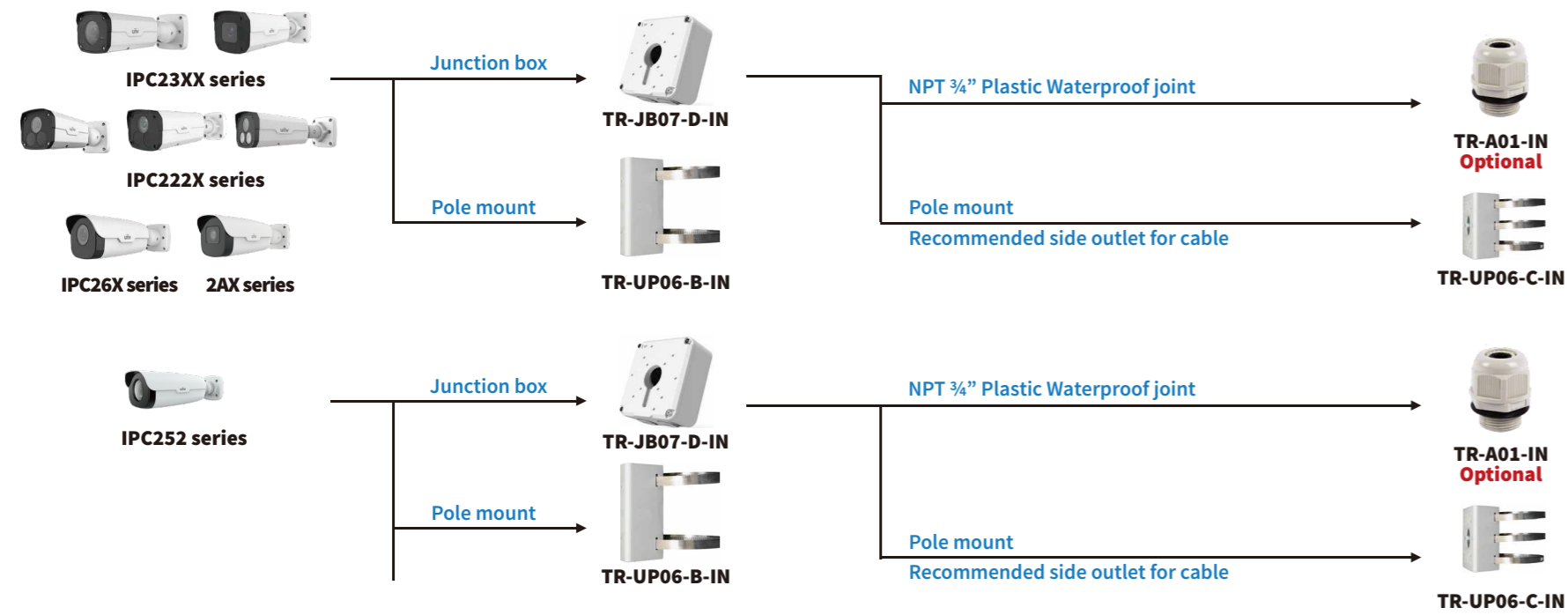

IP Camera Bracket

Mini Bullet camera mount

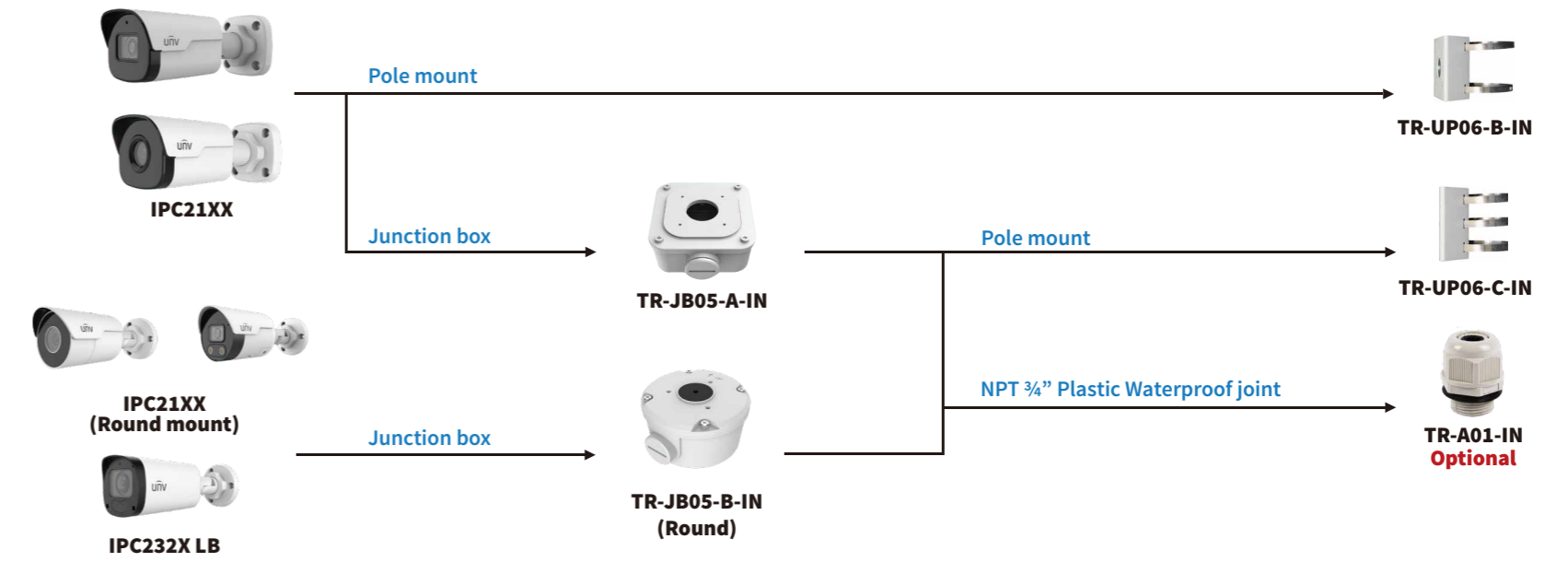

IP Camera Bracket

Outdoor mini PTZ camera mount

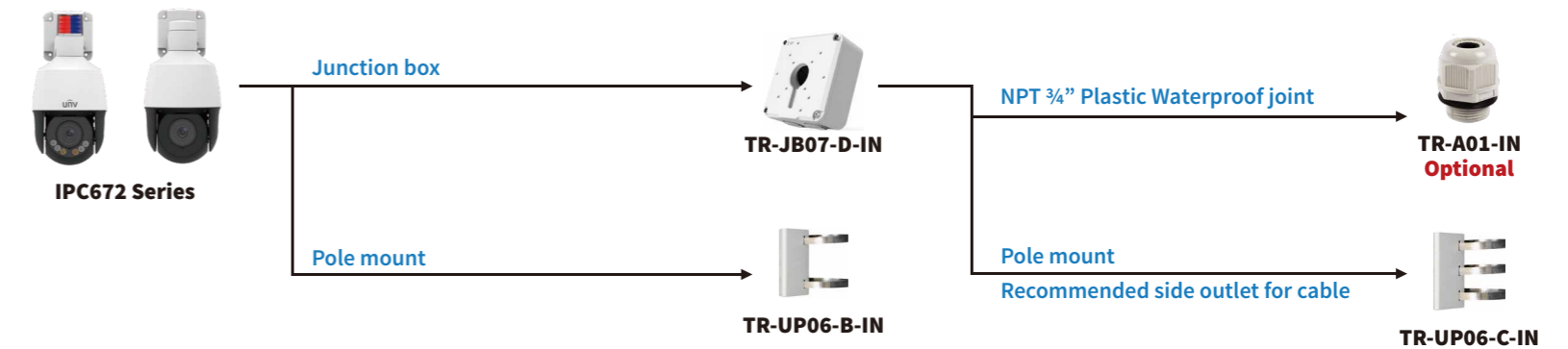

IP Camera Bracket

PTZ camera mount

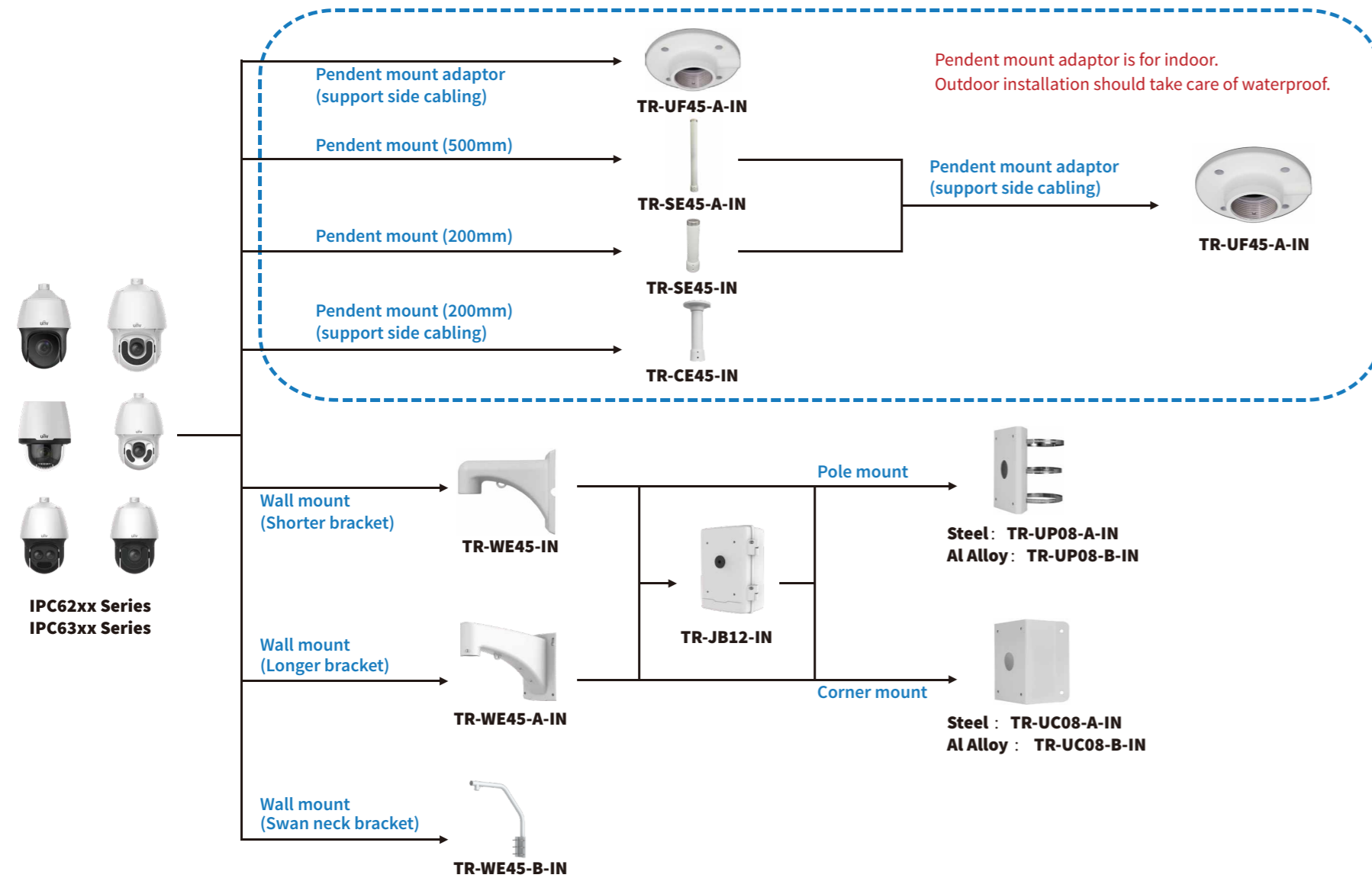

IP Camera Bracket

PTZ camera mount

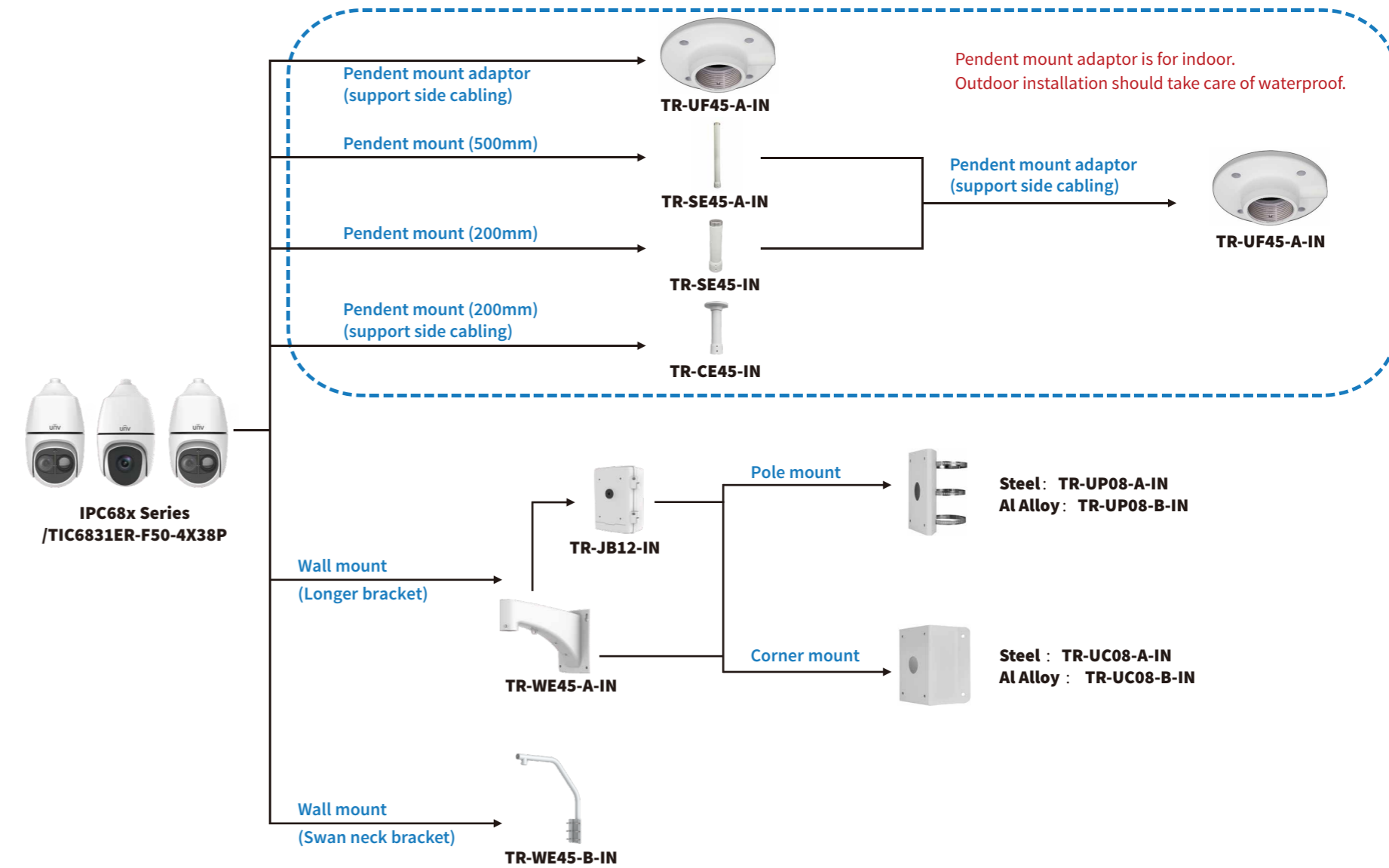

IP Camera Bracket
Indoor PTZ camera mount

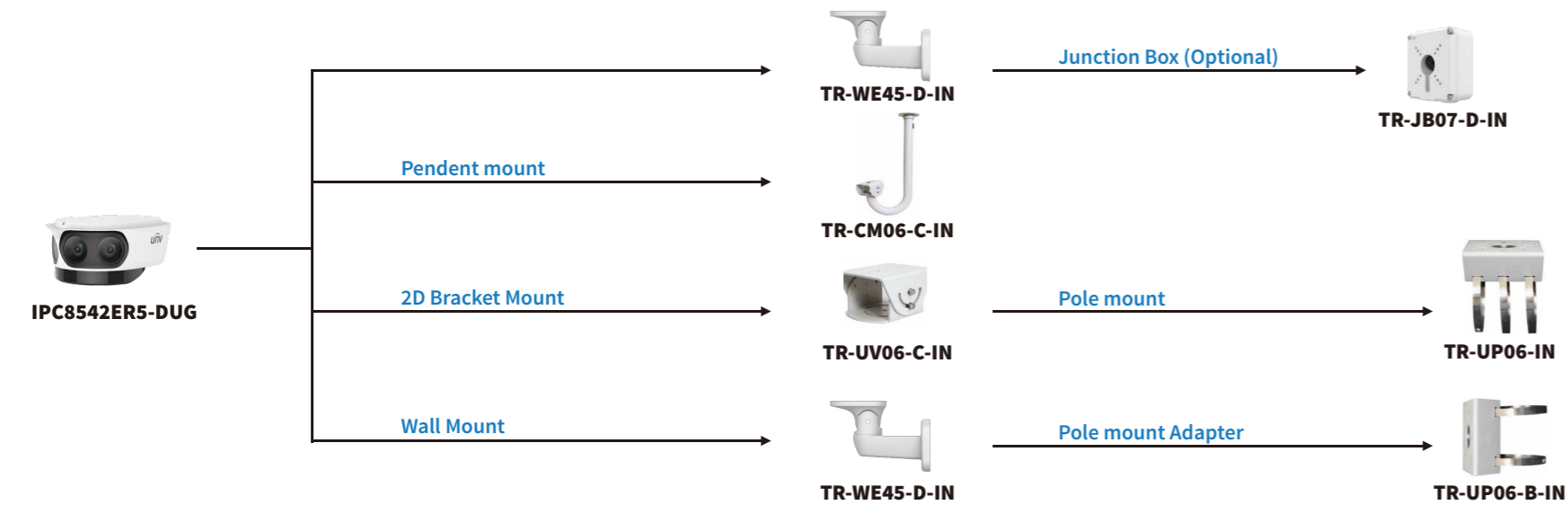
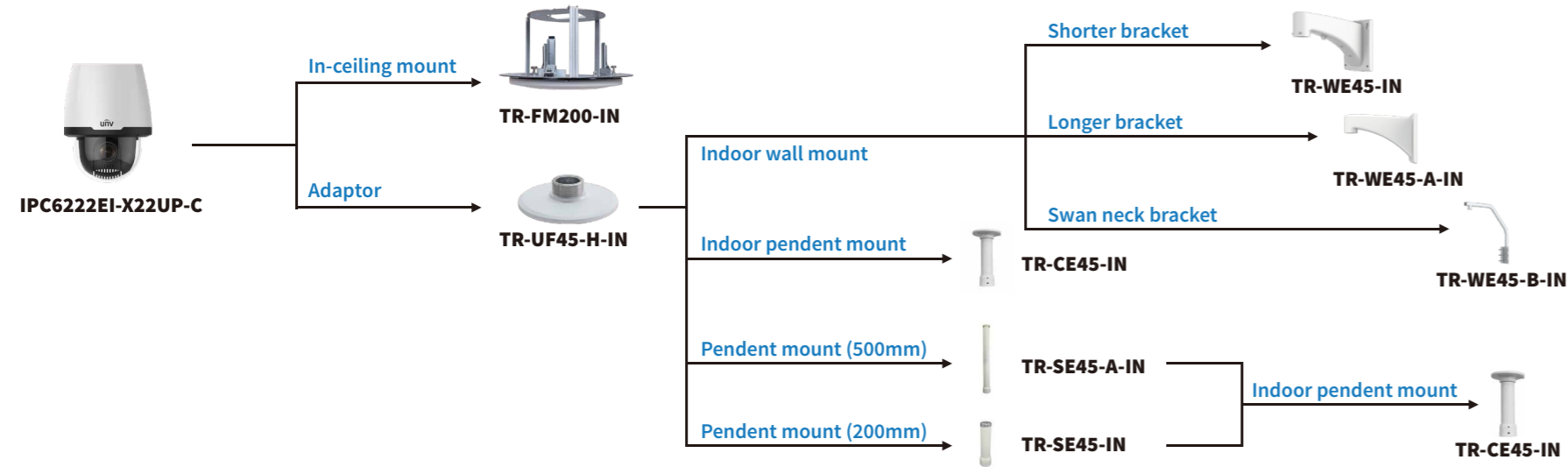



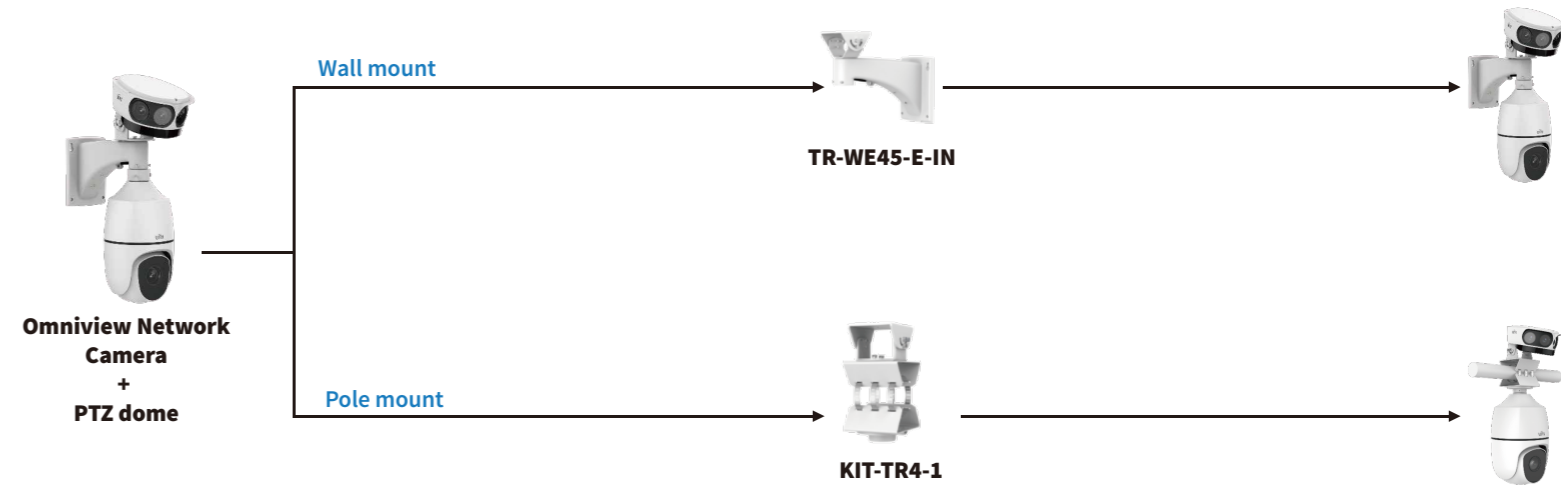

IP Camera Bracket
Omniview Network Camera + PTZ dome mount

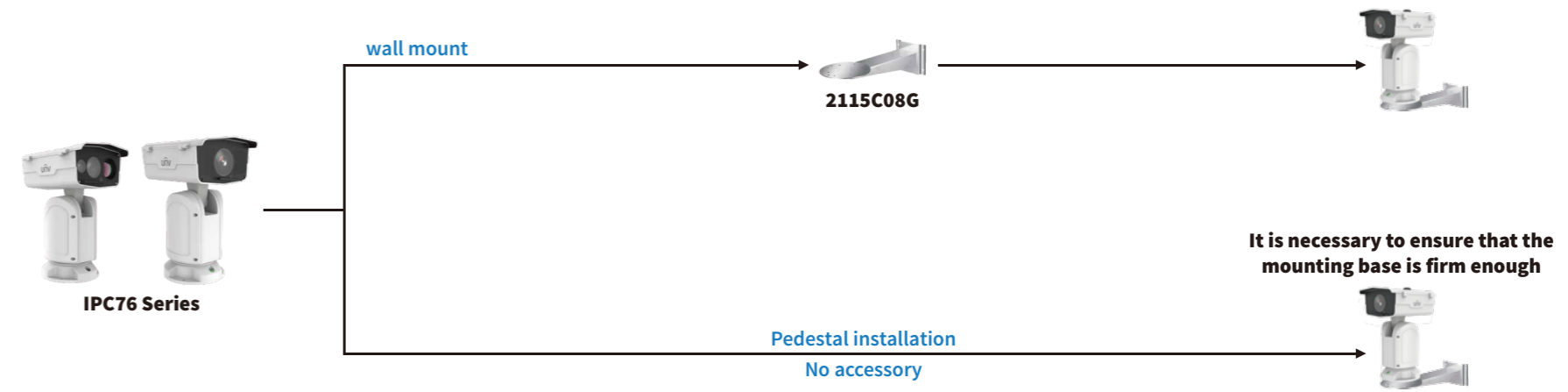



IP Camera Bracket
Positioning system mount





Switch

Model	NSW2010-6T-POE-IN	NSW2010-10T-POE-IN	NSW2010-16T2GC-POE-IN	NSW2010-24T2GC-POE-IN	NSW5110-24GT4GP-IN
Appearance					
Ports	6×100Mbps network ports (RJ45), including 4 PoE ports	10×100Mbps network ports (RJ45), including 8 PoE ports	16×100Mbps PoE ports (RJ45)+2×1000Mbps Combo ports	24×100Mbps PoE ports (RJ45)+2×1000Mbps Combo ports	24×1000Mbps ports (RJ45)+2×1000Mbps Fiber(SFP) ports+2G Combo ports
Standards	IEEE802.3,IEEE802.3u,IEEE802.3az,IEEE802.3x,IEEE802.3af,IEEE802.3at	IEEE802.3,IEEE802.3u,IEEE802.3az,IEEE802.3x,IEEE802.3af,IEEE802.3at	IEEE802.3,IEEE802.3u,IEEE802.3z,IEEE802.3ab,IEEE802.3x,IEEE802.3af,IEEE802.3at,IEEE802.3az	IEEE802.3,IEEE802.3u,IEEE802.3z,IEEE802.3ab,IEEE802.3x,IEEE802.3af,IEEE802.3at,IEEE802.3az	IEEE802.3, IEEE802.3u, IEEE802.3z,IEEE802.3ab, IEEE802.3x
MAC	2K	8K	16K	16K	8K
Packet forwarding rate	0.90Mpps	1.49Mpps	5.36Mpps	6.55Mpps	41.66Mpps
Switching capacity	1.2Gbps	2Gbps	7.2Gbps	8.8Gbps	56Gbps
EXTEND mode	Default(Normal mode) : All ports can communicate with each other. VLAN(Secure mode): Downlink ports can communicate only with uplink ports. EXTEND(Surveillance mode): Transmission distance up to 250 meters.Downlink ports can communicate only with uplink ports.	Default(Normal mode) : All ports can communicate with each other. VLAN(Secure mode): Downlink ports can communicate only with uplink ports. EXTEND(Surveillance mode): Transmission distance up to 250 meters.Downlink ports can communicate only with uplink ports.	Default(Normal mode) : All ports can communicate with each other. VLAN(Secure mode): Downlink ports can communicate only with uplink ports. EXTEND(Surveillance mode): Transmission distance up to 250 meters.Downlink ports can communicate only with uplink ports.	Default(Normal mode) : All ports can communicate with each other. VLAN(Secure mode): Downlink ports can communicate only with uplink ports. EXTEND(Surveillance mode): Transmission distance up to 250 meters.Downlink ports can communicate only with uplink ports.	-
PoE	802.3at/af Max capacity: 65W Max capacity for single port: 30W	802.3at/af Max capacity: 120W Max capacity for single port: 30W	802.3at/af Max capacity: 250W Max capacity for single port: 30W	802.3at/af Max capacity: 370W Max capacity for single port: 30W	-
Mean Time Between Failure (MTBF)	>50000 hours	>50000 hours	>50000 hours	>50000 hours	>50000 hours
DC voltage/AC voltage	AC: 100-240V, 50/60Hz	AC: 100-240V, 50/60Hz	AC: 100-240V, 50/60Hz	AC: 100-240V, 50/60Hz	AC: 100-240V, 50/60Hz
Operating temperature	0°C-40°C (32°F-104°F)	0°C-40°C (32°F-104°F)	0°C-40°C (32°F-104°F)	0°C-40°C (32°F-104°F)	0°C-40°C (32°F-104°F)
Operating humidity	10%~90% (noncondensing)	10%~90% (noncondensing)	10%~90% (noncondensing)	10%~90% (noncondensing)	10%~90% (noncondensing)
Storage humidity	5%~90% (noncondensing)	5%~90% (noncondensing)	5%~90% (noncondensing)	5%~90% (noncondensing)	5%~90% (noncondensing)
Dimensions (W×D×H)	160mm x 93mm x 32mm(6.3×3.7×1.3)	220mm x 150mm x 44mm(8.7×5.9×1.7)	440mm x 207mm x 44mm(17.3×8.1×1.7)	440mm x 207mm x 45mm(17.3×8.1×1.8)	440mm x 208mm x 44mm
Management	-	-	-	-	Configure switch remotely through Telnet/ Web Link aggregation and VLAN configuration Port/MAC information viewing and find problems remotely

Network Cable

Model	CAB-LC2100B-IN	Model	CAB-LC3100B-IN
appearance		appearance	
Cable Type	CAT5E	Cable Type	CAT6
Material/Copper Content	OFC	Material/Copper Content	OFC
AWG	24	AWG	23
Insulation Material	HDPE	Insulation Material	HDPE
Sheath Material	PVC(complies RoHS/REACH)	Sheath Material	PVC(complies RoHS/REACH)
Ambient Temperature	-20°C-60°C	Ambient Temperature	-20°C-60°C
Certification	UL, CPR	Certification	UL, CPR

Model	CAB-LC3200A-IN	Model	CAB-LC3110B-E-IN
appearance		appearance	
Cable Type	CAT6	Cable Type	CAT6
Material/Copper Content	OFC	Material/Copper Content	OFC
AWG	23	AWG	24
Insulation Material	HDPE	Insulation Material	HDPE
Sheath Material	PVC(complies RoHS/REACH)	Sheath Material	PVC(complies RoHS/REACH)(IN Jacket) LDPE(OUT Jacket)
Ambient Temperature	-20°C-60°C	Ambient Temperature	-20°C-60°C
Certification	UL	Certification	N/A